

WFT07 2.4GHZ MULTI-LANGUAGE REMOTE CONTROL DEVICE

7 CHANNELS

INSTRUCTION MANUAL v1



Attention

- ▲ pls read the instruction before using the product
- ▲ Please keep this manual

◀ Thank you for purchasing the WFLY product ▶



WFT07

Features

- 1.The large dot matrix LCD display: multi-language, graphical display. simple design, easy operation.
- 2.Original 2.4G technology *ELASPEED* : use of data transfer, greatly improve the handling agility. fully express the fast Lightning : (Note: *ELASPEED* is WFLY exclusive technology).
- 3.Low-voltage design, lower battery consumption, a variety of battery available:such as 4S alkaline batteries , 4S NiMH(Nickel Metal Hydride), 1S lithium-ion battery , 1S lithium polymer battery . Voltage range 3.7V-6V.
- 4.Super anti-interference: the high spread spectrum (DSSS) + frequency hopping, can boot the 60 sets at same time without interfere.
- 5.Optimization features into the design, operation .

Service

- 1.The WFLY warranty the quality of science and technology within a year (WFLY technology to bear the postage, the user must provide a warranty card and proof of purchase,Indispensable).
- 2.Warranty card and proof of purchase effective by signed and sealed by the seller , and the information must be completed.
- 3.Artificially damaged and over one year after the warranty period, the WFLY provide life long science and technology service,only the users pay return postage, materials fees and maintenance costs.
- 4.This warranty is limited to China's remote control and accessories sales .
- 5.Seller does not give warranty card or do not fill out required from the seller to bear all the after-sales service.

CONTENTS

WFT07 Remote control device contents	1
WFT07 Remote control device	1
WFT07 RC device parts of the name(front)	2
WFT07 RC device parts of the name(back)	3
Instructions of the 2.4Ghz receiver	4
WFT07 code match instructions	5
Trainer function	6
Special symbol instructions	7
WFT07 RC device characteristics	8
Express of input and buttons	9
Adjustment of stick head	9
Replacement throttle hand	10

Helicopter Functions System Settings

Input mode and Functions	11
1.Model parameters	13
2.Model Settings	13
3.Coaching / Simulation	13
4.Control stick settings	14
5.Control stick Calibration	14
6.Restore factory settings	15
7.Tone settings	15
8.Contrast settings	15
9.Power supply scheme	16
10.Version information	16

Preferences

1.Monitor	17
2.Dual Rate	17
3.Servo Reverse	18
4.End point	18
5.Sub trim	19
6.Trim settings	19
7.Throttle curve settings	19
8.Pitch curve settings	20
9.Throttle cut settings	20
10.Throttle holding settings	21
11.Timer	21
12.Swashplate	22
13.Gyro sens mixing	23
14.Advanced settings	23

CONTENTS

Advanced settings

1.Speeder mixing	24
2.Fail safe	24
3.code match	25

Airplane Functions system settings

Input mode and functions	26
1.Model parameters	27
2.Model settings	27
3.Coaching / Simulation	27
4.Control stick settings	27
5.Control stick calibration	27
6.Restore factory settings	27
7.Tone settings	27
8.Contrast settings	27
9.Power supply scheme	27
10.Version information	27

Preferences

1.Monitor	27
2.Dual Rate	27
3.Servo Reverse	27
4.End point	27
5.Sub trim	27
6.Trim settings	27
7.Flaperon mixing	27
8.Flap trim	28
9.Aileron diff control	28
10.Elev-flap	28
11.Throttle curve settings	29
12.Throttle cut settings	29
13.Throttle holding settings	29
14.Timer	29
15.Advanced settings	29

Advanced Settings

1.Elevator mixing	29
2.Ele-Aileron mixing	30
3.V-tail	30
5.Ail-2	30
6.Fail safe	31
7.Code match	31

WFT07 Remote control device contents

1.WFT07 remote control device	1 set	2. WFR07S 2.4Ghz receive	1 Only
3.Simulator switch cable	1 Root	4.Transmitter 4cell battery case	1 A
5.Manual	1 This/zhang	6. WFLY neck strap	1 Article

WFT07 remote control device diagram



1. WFT07 remote control device



2. WFR07S 2.4Ghz receive



3. Simulator switch cable Manual

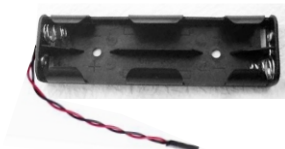

4. Transmitter 4cell battery case



5. Manual/CD-ROM



6. WFLY neck strap

WFT07 RC device parts of name

WFT07 RC device Positive

(Right hand throttle)

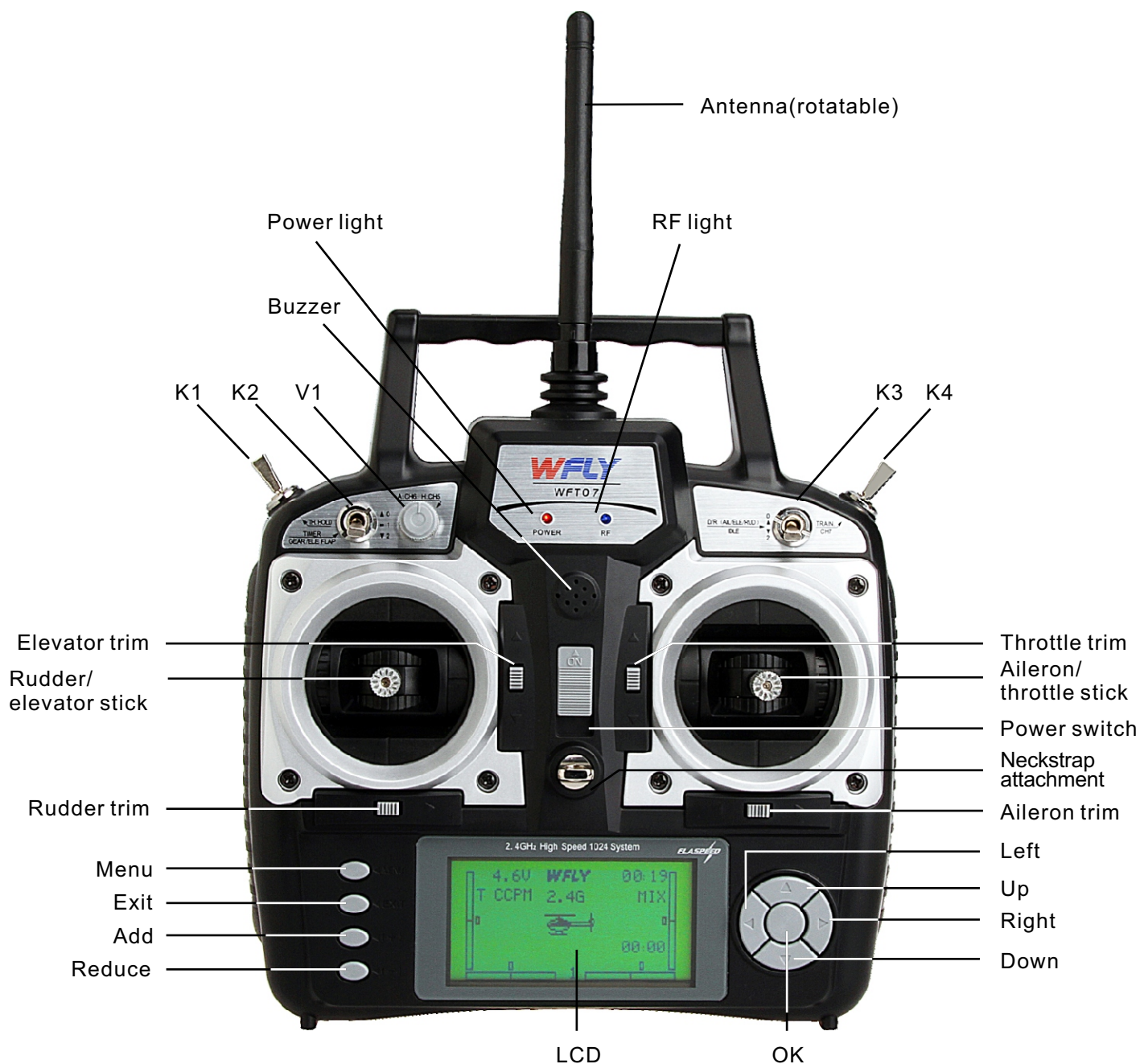

K1: 2 stalls. Throttle holding and throttle cut

K2: 3 stalls. Timer , airplane 5channel and airplane Elev-flap mixing.

K3: 2 stalls. Dual rate, Fight mode (normal,special IDLE)

K4: Trainer. 7channels

WFT07 RC device parts of name ▲

WFT07 RC device back



Instruction of 2.4Ghz receiver ▲

Model:WFR07S

Type: 7channel 2.4Ghz receiver,4096 resolution(in the PCMS 4096 resolution)
(Adaptation WFLY 2.4Ghz series),ORGANIC 2.4G **FLASPEED**

Voltage :4.8V-6V

Current:30mA

Weight:9.6g

Size: 40.42mm x27.27mm x11.88mm

Frequency: 2.400GHz-2.483GHz

- | | |
|---------------------------|------------------|
| 1. AIL: Aileron | (Channel 1)----- |
| 2. ELE: Elevator | (Channel 2)----- |
| 3. THR: Throttle | (Channel 3)----- |
| 4. RUD: Rudder | (Channel 4)----- |
| 5. GRY: Landing Gear/Gyro | (Channel 5)----- |
| 6. PIT: Pitch | (Channel 6)----- |
| 7. Auxiliary channel | (Channel 7)----- |
- (Note: Any channel can be used as power input)



WFLY PCMS receiver cam compatible with PCMS 4096, PCMS 1024 and PPM modulation (Adaptive), and have fail safe function.ORGANIC 2.4G **FLASPEED**

WFT07 instructions of the code match

1. Remote control device settings

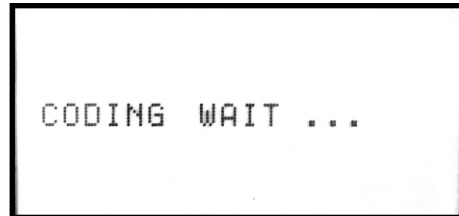
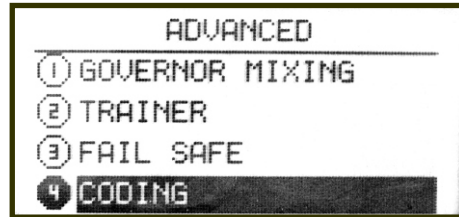
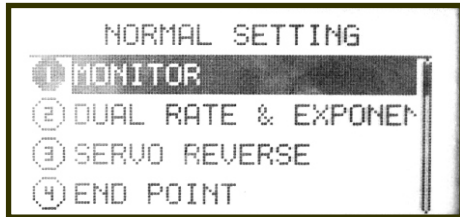

Function instruction:

The remote control for the 2.4G spread spectrum, frequency hopping systems, have high anti-interference. The remote control has unique

Settings

Into the "Advanced Settings" menu item under the "Preferences" . Press confirm button to enter the "code" interface in the "Advanced Settings" . As above. The specific settings as follows: 1. The first use the button to select on the code, the code

address identification code information, Before use the remote control, pls match the code with the 2.4Ghz receiver.

process needs within a short distance. 2.4G module system in the closed state is not available, please refer to "Coaching / Simulation" Once Code successfully will return to the menu. Also can press "exit" button to return.

 **Warning**

When using this function, please ensure that no other remote control operating!

2. Receiver Settings

Remote control device into this interface:

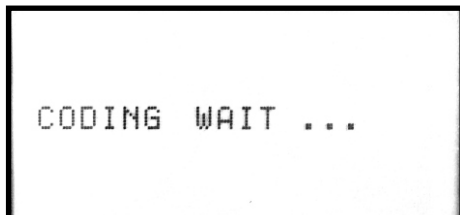

Then going receiver settings: receiver hold "SET" button until the STATUS indicator light flashes slowly, waiting for the transmitter of the code instructions.



After the success of the code ,the LED light is off, you can normally using.

 **Note:** The code required in a short distance.

Trainer Function ▲



Instruction of the Training function

The same two remote control devices WFT07 can do the Trainer function:

Settings:

1. Using the simulator cable to connect two WFLY equipment.
2. Trainer settings: Press MENU key to boot into the "System Settings" function, enter " Training / simulation "menu,selected the" trainer mode ", (effect after re-boot).
3. Student machine setting: Press MENU key of the another radio into the "System Settings" function, entry "Training / simulation "menu,selected the " Simulator Mode ", (effect after re-boot).
4. Release Trainer switch K4, this time the student machine does not sending signal, the operation completed by the trainer.Advance push the trainer switch K4, then operation completed by the Student machines now.

Note the special symbol ▲

For the safe use of this product, pls pay attention to The marks have the following description of symbols.

- ▲ **Dangers:** If you use in without a proper operation, it is possible to hurt user seriously injury or may even cause death .
- ▲ **Warnings:** If you use it without proper operation, it may make the user or others to hurt badly or may even cause death, and it may cause slight hurt or damage to things
- ▲ **Warning:** Children under 14 must be accompanied by an adult using
- ▲ **Notices:** If you use it without a proper operation, it may cause user to hurt slightly or damage things, but it won't hurt you seriously normally.
- ▲ **Note:** Turn on the Transmitter first, then turn on the receiver; after play pls turn off the Receiver first, then the Transmitter

Flight Precautions

⊘ Prohibitions ● Compulsory Items ▲ Warning

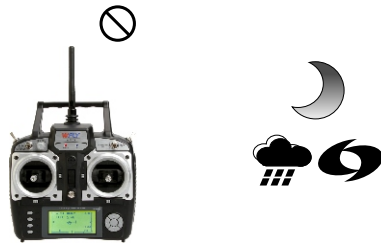

⊘ Do not fly in the evening, rain, or strong wind.
Possible damage to equipment or aircraft accidents.

The Feature of WFT07 Remote control device ▲

- Large graphic dot matrix LCD display, easy to operate.
- Multi-language
- WFT07 RC device is the multi-function proportion of 7ch remote control .
- The original 2.4G technology , with data transfer , which greatly improve the handling agility *ELASPEED* Fully explain the fast as lightning. (Note: The *ELASPEED* is the WFLY exclusive technology).
- Low-voltage design, lower battery consumption, a variety of battery available: such as 4S alkaline batteries , 4S NiMH(Nickel Metal Hydride), 1S lithium-ion battery , 1S lithium polymer battery . Voltage range 3.7V-6V.
- joystick of elastic, are free to adjust the hength of the head. The new shape of the head makes a good Feel.
- Digital electronic tuning, 250 steps adjustable.
- Complete the timer function to ensure flight foolproof
- Monitor function can more intuitive operation.
- Training function
- Perfect timing function
- Up to 11 groups of curves, easy to deal with difficult moving actions.
- Multiple mixing control system , adjustable 9 point of the curve .
- A variety of flight patterns, ease flight.

Instruction of the input function ▲



MENU:

After booting, press the menu button to enter the function menu - Preferences. In addition, if the in the function interface, press this key will be Back to the menu.

EXIT:

Press this key, you can return to the previous menu level, or exit the edit state.

Add/Reduce Key:

Can be used to adjust values. Also set numerical value, press + / -, can accelerated settings the functions.

Arrow Keys:

Arrow keys are divided into upper and lower, left and right keys, can be used to switch the set up Or edit the item.

Confirm key:OK key (this machine confirm key have three kinds of function)

- ※. With the menu to access the item.
- ※. To enter the edit mode.
- ※. Press this button long time, the selected item restore the default value

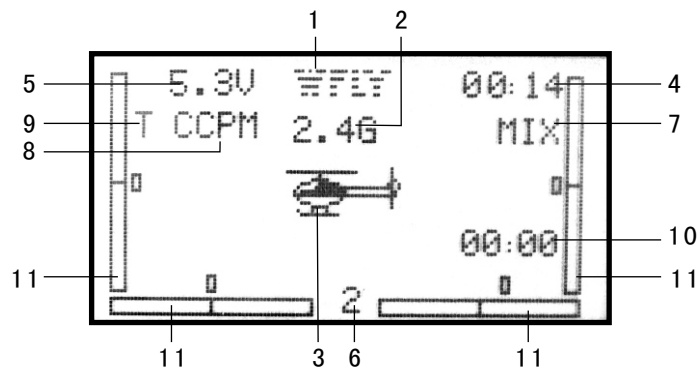

1.WFLY LOGO

2.2.4G RF circuit directed: shown 2.4G under work, closed without the logo.

3. Aircraft models: helicopter mode, shows the helicopter LOGO, airplane mode, shows the airplane LOGO.

4. Accumulative used time: to display the cumulative duration of the using, can also be reset clear.

5. Battery voltage display.

6. Model data file shows: 1,2,3 ... and so on.

7. Mixing status shows: mixing state (throttle holding, throttle cut, stunt mode) display MIX.

8. Helicopter swashplate shows: If you set a non-normal mode of swashplate, will show CCPM.

9. Trainer function display: Trainer mode will show "T",with flashing.

10. Timer display.

11. Digital electronic tuning: graphics + value dual display,and with tone reminder.

Adjustment of stick head

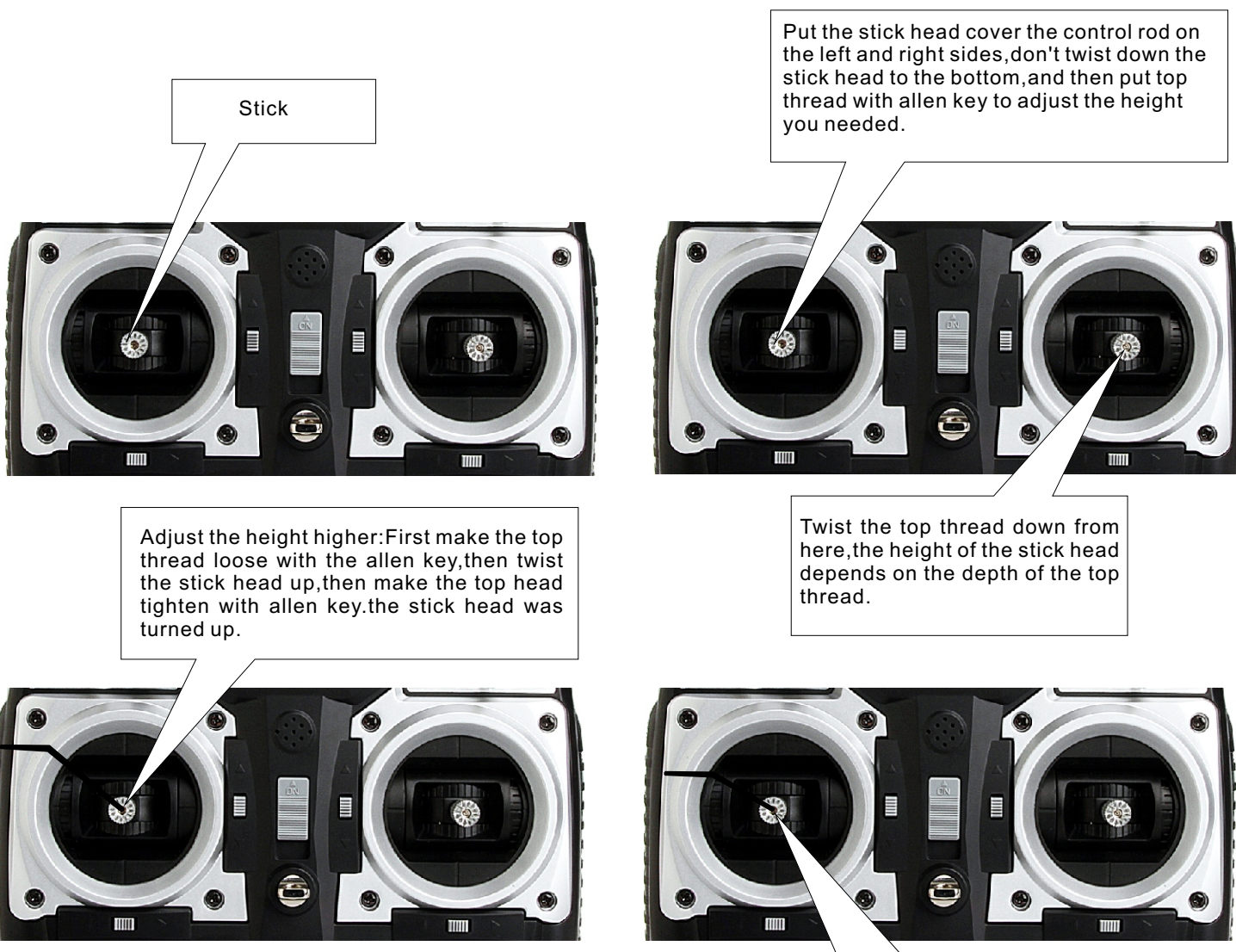
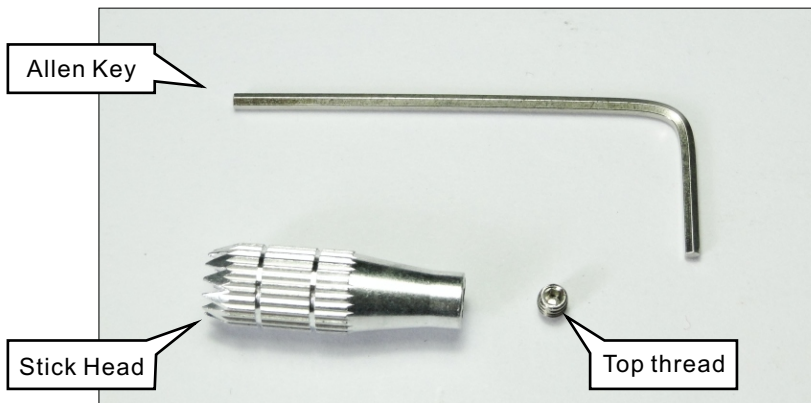

Steps:

1. Put the stick head on the stick.
2. Put the top thread in the stick head with allen key.
3. Adjust top thread in the stick head with allen key to fix the height of the stick head.

Replacement the throttle of mode 1 or 2

Right-hand man will lose their own free replacement warranty program

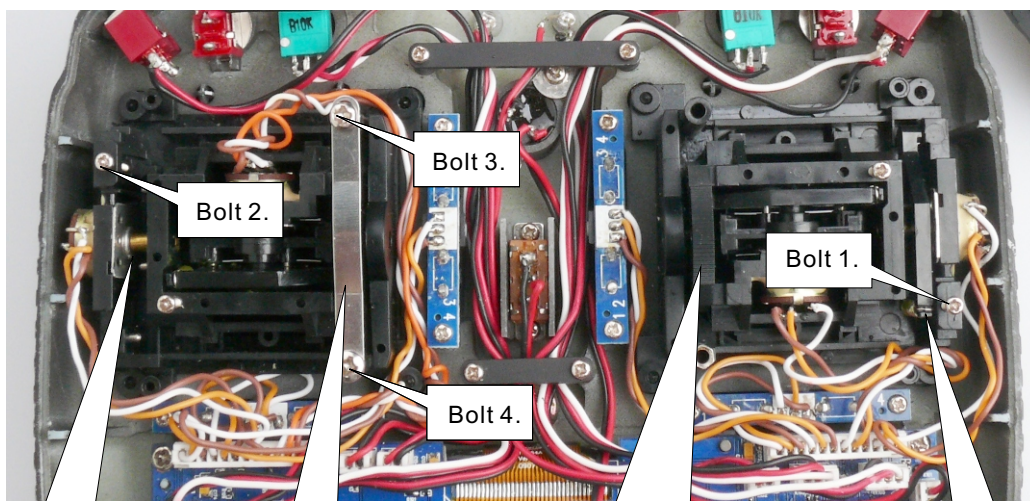

Set up release link and springer, according your habit to adjust the tightness of screw 2 to adjust the control felling.

Take the metal chip and screw down, and put it on the similar position of the right side.

Put on the metal chip, according your habit to adjust the elasticity of screw 3 and screw 4 to adjust the damp of throttle control felling.

Take release link and spring Down, and put it on the left side of the location of corresponding, then twist bolt1 down until withstand the adjust nail ,in case adjust nsil will move away.

Helicopter Functions

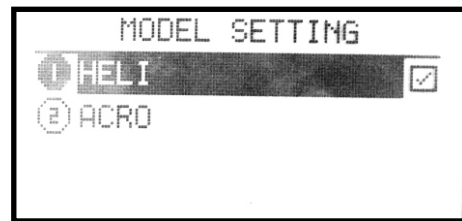
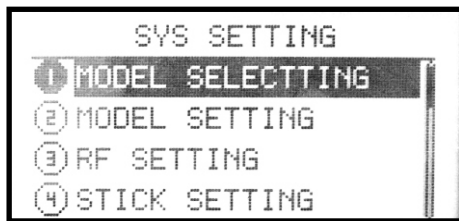

Introduction

This section are mainly introduces the helicopter functions. Please press the MENU button to turning on the radio in turing off state, you can enter the "System setting" menu, Up / Down arrow keys to select" Model Settings ", press the Enter key to enter the function setting interface, (as above). Please choose the model, re-boot, then the transmitter can display the functions of the helicopter with the detailed description of each function

Input mode and function introduction ▲

1. The main interface

When the power turned on, the interface as shown. In this state, the user can view the machine voltage, time display, model type and aileron, Throttle, elevator, rudder and so on trim state

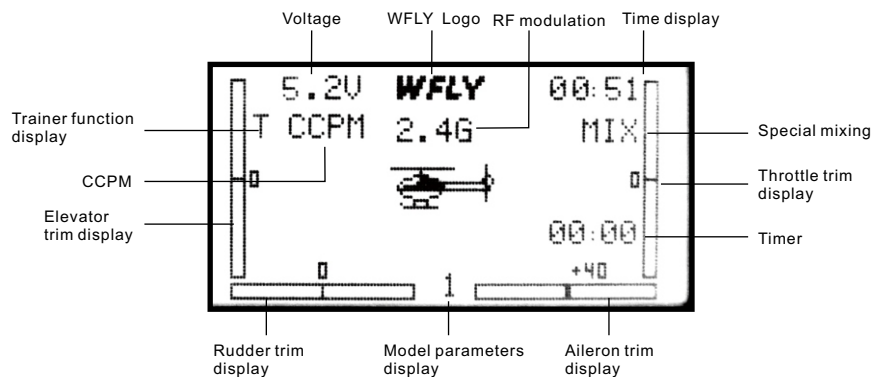

2.Function Menu-There are "System settings","Preferences"and "Adcanced settings"

A. System Settings

In close state, hold down the MENU key, then turning on the power, you can enter the "System Settings" menu page, the interface as shown.

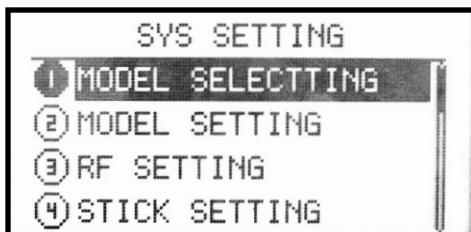

In this state, all functions can be set one by one. As follows:

1. Use the arrow keys on the screen to select the functions you needed, use up and down keys to select function items. With the left and right arrow keys to flip.
2. In the functional state ,press OK key to enter sub-menu of the function. The function of specific configuration, please refer the next chapter.
3. When Settings finished, press EXIT key to return to superior menu,it will automatically store the Settings value.

B. Parameter Settings

In the boot screen, press the MENU button on the left screen, you can enter the "settings" menu page, the interface as shown.

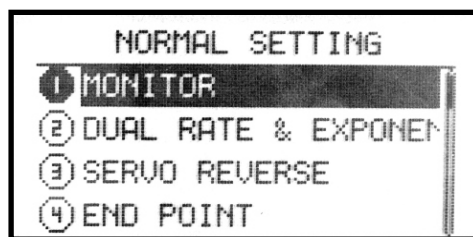

In this state, the machine can be set one by one the various functions. As follows:

1. Use the arrow keys on the screen to select the functions you needed, use up and down arrow keys to select function items. With the left and right arrow keys to flip.
2. In the functional state ,press OK key to enter sub-menu of the function. The function of specific configuration, please refer the next chapter.
3. When Settings finished, press EXIT key to return to superior menu,it will automatically store settings Value.

C. Advanced Settings

Into the "Preferences" menu, use the left and right arrow keys to flip, can see the "Advanced Settings" function key. Click OK key to enter.

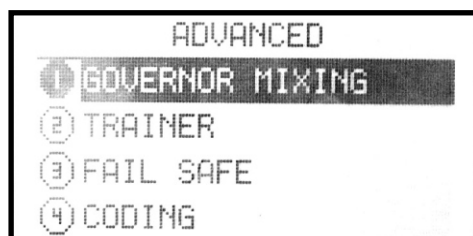

In this state, the machine can be set one by one the various functions. As follows:

1. Use the arrow keys on the screen to select the functions you needed, use up and down arrow keys to select function items. With the left and right arrow keys to flip.
2. In the functional state , press OK key to enter sub-menu of the function. The function of specific configuration, please refer the next chapter.
3. When Settings finished, press EXIT key to return to superior menu, it will automatically store settings Value.

System Settings Menu Introduction

1. Model Parameters

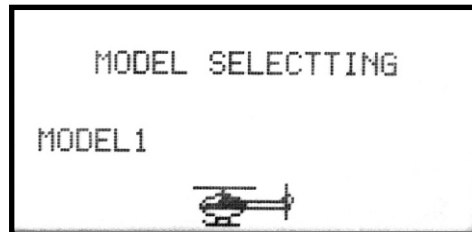
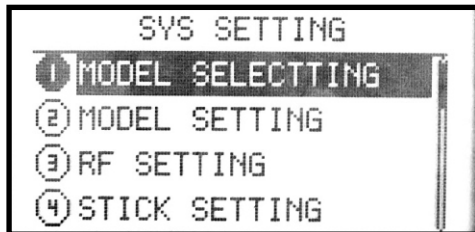

● **Function**

Model parameters function totally have three machines for the user to choose, you can select

any of them model to settings.

● **Settings**

Press the MENU button to boot into the "System Settings" menu, use Up / Down keys to select the "model parameter settings", and press the "OK" key into the function interface, as shown above.

The steps of setting is as follows:

1. Using the up / down keys to select different models.
2. Selected the options, press OK key to select .
3. Settings successfully, press EXIT key to exit.

2. Model Settings

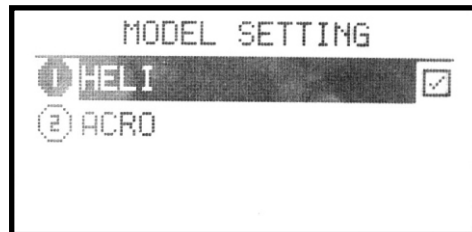
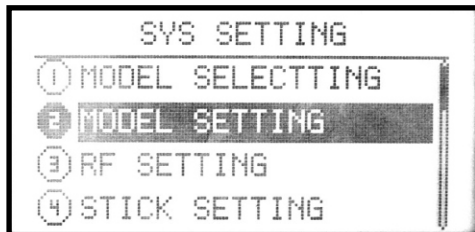

● **Function**

Model settings can be used to set to the

helicopters, airplane as you needed.

● **Settings**

Press the MENU button to boot into the "System Settings" menu, use Up / Down keys to select "Model Settings", press the OK key into this function interface, as shown above.

The steps of setting is as follows:

1. Up / Down keys to select the model.
2. Click OK key to confirm.
3. Settings finished, press EXIT key to return to

3. Coaching / Simulation

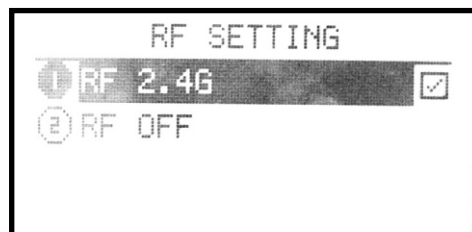
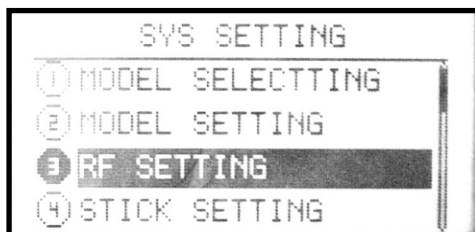

● **Function**

- ◆ Normal: normally use the model, RF 2.4GHz work, do not support the trainer.
- ◆ Trainer mode: use the unit as a trainer, use the training cable connect the other one as a student machine. through the unit RF 2.4G machine control, with the K4 switch. Not switch K4 is sending the trainer machine signal, when push

the switch K4 is sending the student machine signal.

- ◆ Simulator Mode: This mode will turn off RF 2.4G in order to facilitate learning with other remote control. Or connect with the computer to simulate the flight to reduce power consumption to increase the use of time.

⚠ **Note:** For security, the above mode switch to take e

ffect after reboot.

●Settings

Press the MENU key to boot into the "System Settings" menu, use Up / Down arrow keys to select the "trainer / Simulator", press OK key to enter the function interface, as shown above. The steps of setting is as follows:

- 1, first to use the up / down arrow keys to edit the selected item.
2. Press OK button to confirm, then press the right arrow keys to determine. Reboot to take effect.

4. Control Stick Settings

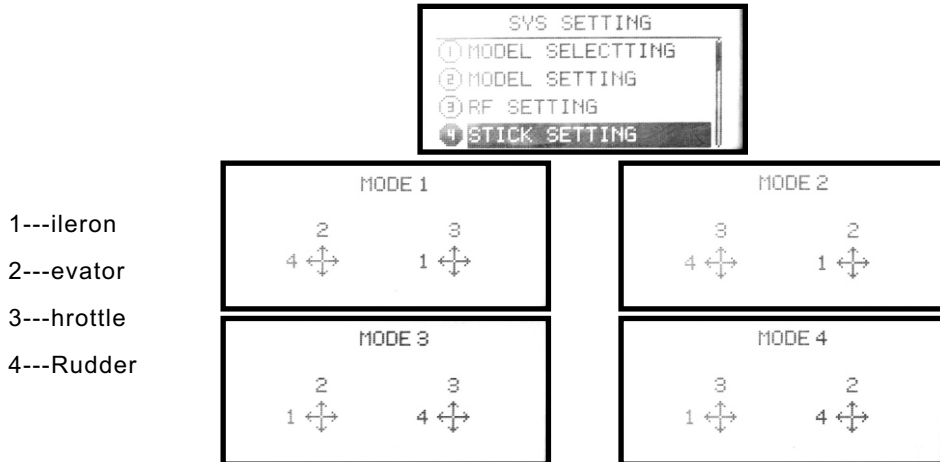

●Function

Control stick settings function allows users to freely setting the higher of the stick according to personal preferences . As shown. This machine

Totally have four models to choose .

●Settings

Press the MENU key to boot into the "System Settings" menu, use Up / Down keys to select the "stick settings" and press OK key to enter this function interface, as shown above. The steps of settings is as follows:

1. First to use the arrow keys to select the edited item .
- 2 Use Up / Down key to implementation Stick Mode .
3. Set successfully, press EXIT key to exit.

5. Stick Calibration

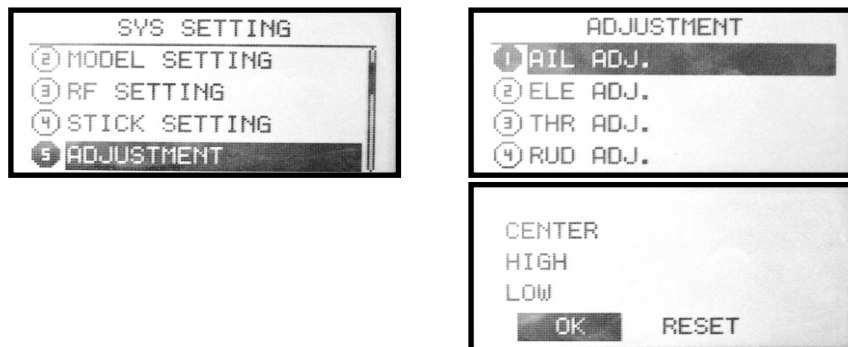

●Function

Joystick calibration function allows users to change the throttle side according to personal

preferences . 图3

●Settings

Press the MENU key to boot into the "System Settings" menu, use Up / Down keys to select "Stick calibration" and press OK key to enter the function interface, as Shown above. Specific settings, follow these steps: 1. First to use the arrow keys to select the edited item, (example aileron calibration). 2. Put the calibrate joystick placed in the midpoint of the channel position, options Up / Down - key implementation the control calibration . 3. Selection into the Figure 3. When the "middle" highlighted, press OK key (this time the Point calibrated is OK), into the stick maximum (high) calibration. 4. When the "high" highlighted, put the stick gently leaned on the right

(throttle /elevator on the top edge, aileron / rudder on the right edge), press the OK key (in this case the maximum value has been calibrated), into the stick minimum (low) calibration. 5. When the "low" highlighted, put the stick gently leaned on the left (throttle / elevator on the lowest, Aileron / rudder on the left edge), press the OK key (while the stick minimum calibrated OK). 6. At this memont the bottom of the screen displays "confirmation / reset" and press to OK key , all the calibration is completed, automatically return to the superior menu, use the arrow keys selected to re-enter Calibration Procedures.

6. Restore factory settings

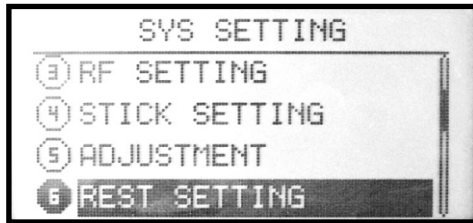

●Function

Reset function is to present the model all the data back to the initial default settings, so can do

Comprehensive settings of re-work. Procedures.

●Settings

Press the MENU key to boot into the "System Settings" menu, use Up / Down keys to select "reset", press Confirm key into the function interface. As above:

The steps of settings is as follows:

1. First to use the arrow keys to select the Edited item.
2. With + / - key to implementation the reset.
3. Set successfully, press EXIT key to return.

7. Tone Settings

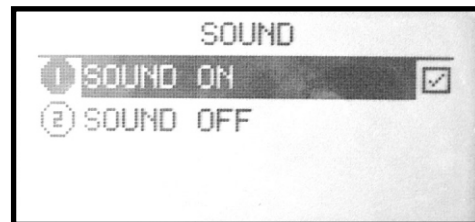
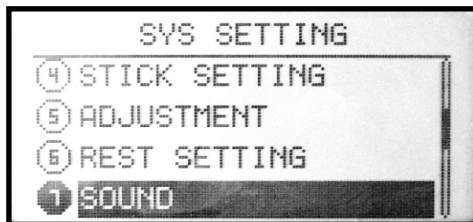

●Function

Tone settings allows users to freely set all the sounds on or off according to personal

Preference.

●Settings

Press the MENU key to boot into the "System Settings" menu, use Up / Down keys to select "Sound", press the OK key to enter the function interface, as above.

The steps of settings is as follows:

1. Into the items, press OK key to select the sound on or off.
2. Automatically saved after confirmation.

8. Contrast Settings

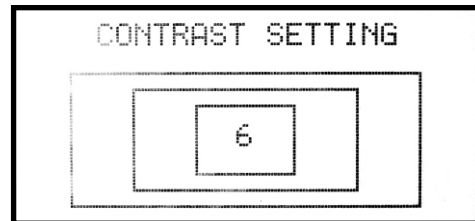
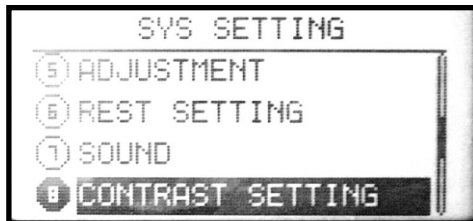

●Function

The contrast setting function can adjust the brightness of the display ,

increase or decrease the contrast value to change the brightness of the screen.

●Settings

Press the MENU key to boot into the "System Settings" menu, use Up / Down keys to select "Contrast settings" and press OK key to enter the function interface , as above.

The steps of settings is as follows:

1. Using the + / - keys to set the value of increase / decrease.
2. Long time press OK key restore the default value.
3. Set successfully, press EXIT key to return.

9. Power supply scheme

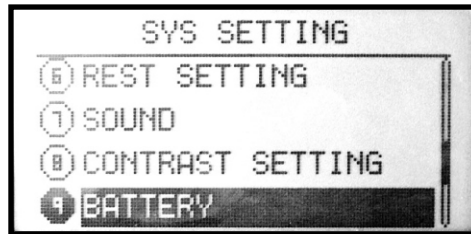

● Function

The machine can use a variety of power options:
If ordinary alkaline AA batteries 4S, Ni-MH / Ni-Cd
battery 4S, Li-Ion / Li-polymer battery 1S.

Different battery in different low-battery voltage
alarm, in order to extend battery life, select the
corresponding power supply plan.

 **Note:** Voltage range 3.7V-6V.

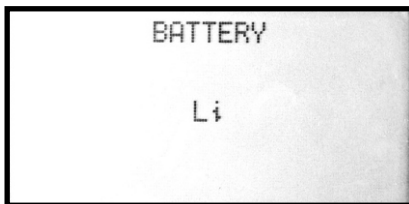

● Settings

Press the MENU key to boot into the "System
Settings" menu, use Up / Down arrow keys to
select "Power Information", press OK button to
enter the function interface. As shown above. The
steps of setting is as follows:

1. The first to use the arrow keys to edit the selected item.
2. Select the power scheme with the + / - key to implementation.
3. Set successfully, press EXIT key to exit.

10. Power supply scheme

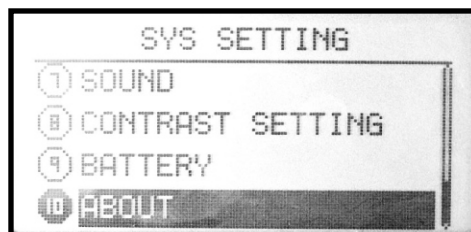

Introduction of the Parameters Settings Menu

1. Monitor

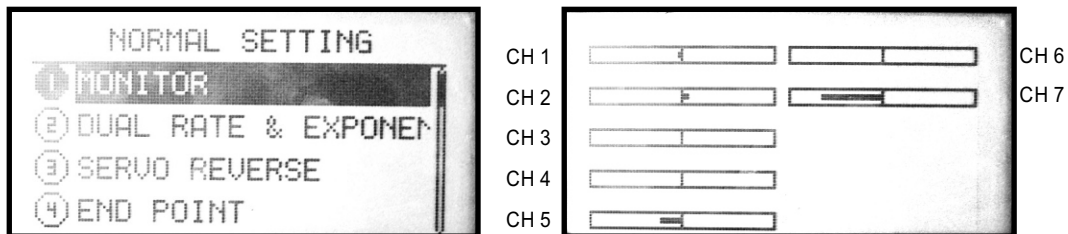

●Function

The monitor function is to monitor and confirm the channel operation state.

●Settings

In the "Preferences" interface, use Up / down keys to select the "Monitor", press OK key to enter the function interface, as above. Then can monitor each channel action condition

2. Dual Rate Settings

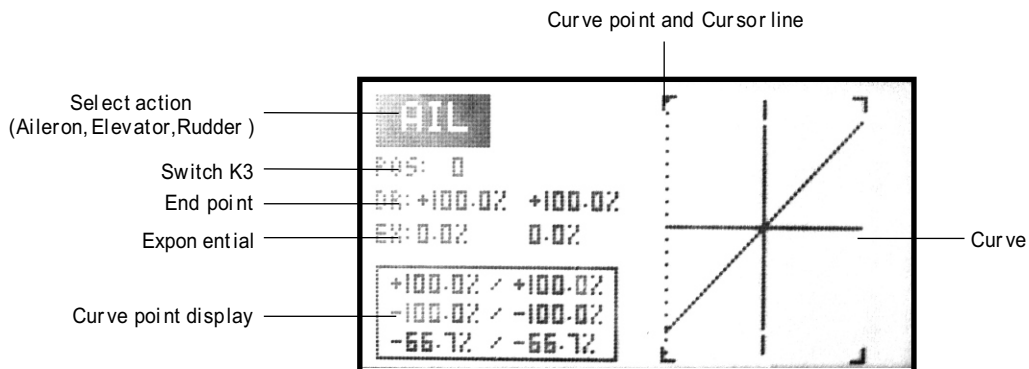

●Function

Dual Rate function is by setting the switch to change the aileron, elevator, and rudder of the control rate.

●Settings

In the "Preferences" interface, use Up / down keys to select the "Dual rate ", press OK key to enter the function interface . As above.

The steps of settings is as follows

1. Select the required channel (eg, aileron, elevator etc.). Use the + / - key to select the required channel, confirmed with OK key.
2. Select the K3 switch position (position 0 or position 2). Use the + / - button to select the required location .

3. Settings the D / R, Use the arrow keys to select the the "D / R 'in screen, when the screen light off, then enter the edit mode of this function. (You can choose settings single parameter or two parameters at the same time), then press + / - keys to change the values ,long press OK key can be recovered to the default value.

4. Settings exponential EX, can change the aileron, throttle and rudder these three channels' joystick sensitivity near the neutral. Dual rate and curve exponential are match, will have a lot of

combinations and settings, with the arrow keys to select the "EX" in the screen, settings way are same as "D / R" .

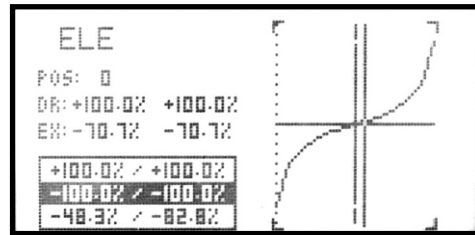
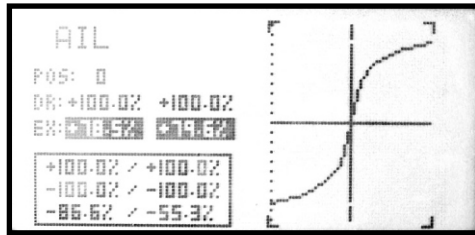

5. Use the arrow keys to select the curve point, + / - key to changing the value of curves point.

6. Set successfully, you can press EXIT key to return.

3.Servo Reverse

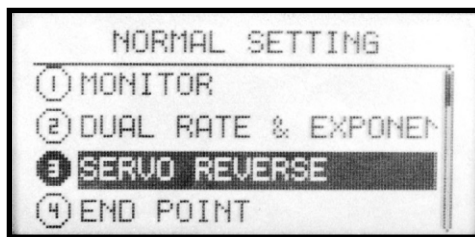

●Function

Servo reverse function can adjust the direction of the servo moves to make the direction of servo

movement is normal or reversed.

●Settings

In the "Preferences" interface, use Up / Down keys to choose "Servo reverse", press OK key to confirm enter the function interface. As above. The steps of settings is as follows:

1. First to use the arrow keys to select the edited item.
2. with + / - keys to switch the action is normal or reverse and use the OK keys to implement.
3. Set successfully, press EXIT key to return.

4.End Point

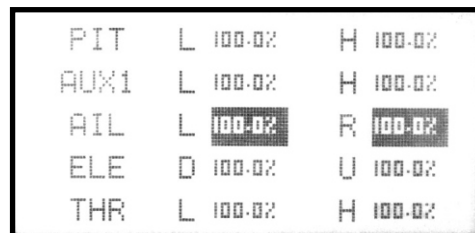
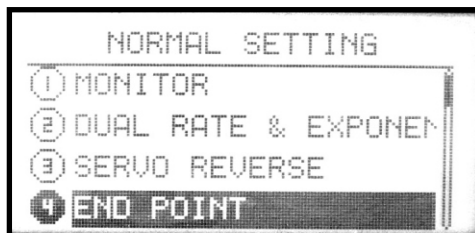

●Function

End point function can determine the end point of the servo's initial value, adjusting the largest

route of servo movements, the adjustment range is between 0% -120%.

●Settings

In the "Preferences" interface, use up / down keys to select the "End point" and press OK key to enter the function interface, as above. The steps of settings is as follows:

1. First use the arrow keys to select the edited items.
2. Set the value of the route with + / - key. Long press OK key to restore the default values.
3. Set successfully, press EXIT key to return.

5.Sub Trim

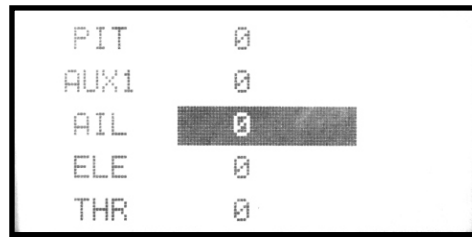
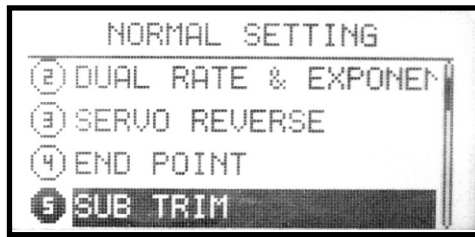

●Function

When the electronic trim can not make the servo to achieve a satisfactory angle, be corrected by the function, can make the servo to reached a

ideal angle which user wanted. When set this function , please place the trim in the central location, then start setting

●Settings

In the "Preferences" interface,use Up / Down keys to select the "Sub trim", press the OK key to confirm you access in this interface, as above. The steps of settings is as follows:

2. Set the amount of the sub trim of movement with the + / - keys or used the OK key to implement, long press the OK key can restore the default value.
3. Set successfully, press EXIT key to return.

1. First to use the arrow keys to select the edited item.

6.Trim Settings

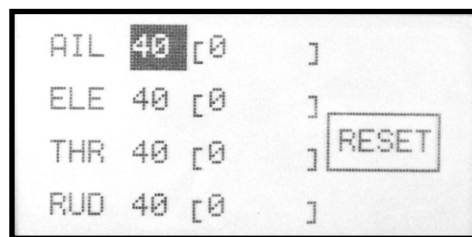
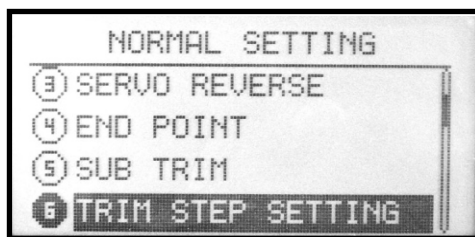

●Function

Trim settings function is adjustment for each trim to change the trim sensitivity, settings amount can

be 1-250.

●Settings

In the "Preferences" interface, use Up / Down keys to select the "Trim" and press OK key to confirm access in this function interface, as above. The steps of settings is as follows:

2. Set the amount of Trim with the + / - key,use OK key to implement. If "reset", can set the trim location value to zero.
3. Set successfully, press EXIT key to return.

1. First to use the arrow keys to select the Edited

7.Throttle Curve Settings

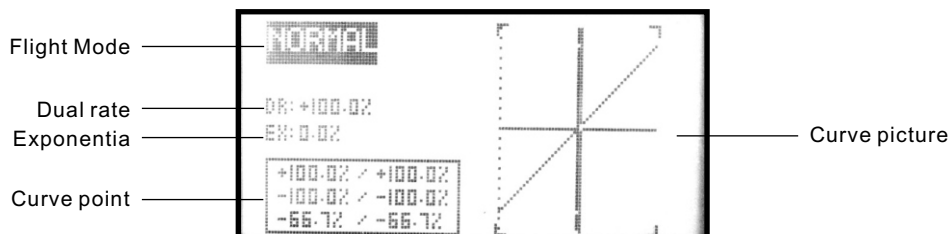

●Function

Throttle curve with the throttle stick position to adjusted the engine flight in the best state. This throttle curve can set to normal and stunt curves and so on.The operation of those curves can carried out by the switch.The throttle curve of normal curve is basic on hovering, the engine rpm

with the pitch can achieve the best effect. Stunt Curve is maintaining a certain engine speed,make the throttle with the pitch to complete the stunts in the flying .

●Settings

In the "Preferences" interface, use Up / Down keys to select the "throttle curve settings", press OK key to confirm enter the function interface, as above.

The steps of settings is as follows:

1. Flight status (normal or stunt). Use the arrow keys to enter edit state, you use + / - keys to select one of the curve, then enter the following settings.
2. Set the D / R, Use the arrow keys to select the "D / R" in the screen, when the screen light off, then enter the edit state of this function (you can

choose individual settings on one or setting on both sides), Press the + / - keys to set the values, long press the OK key to return to the default value.

3. Use left and right arrow keys to select curve points, + / - keys to change the value of curve points.
4. Set successful, you can press EXIT key to return.

8. Pitch Curve Settings

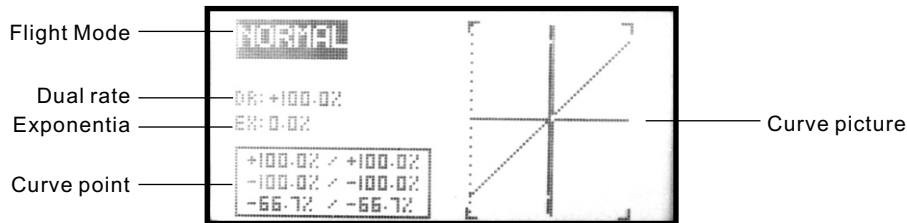

●Function

Pitch curve with the throttle stick position can adjusted the engine rpm flight in the best state, This pitch curve can be set normal, stunt and lock curve and so on. The operation of those curve can carried out by the switch. Pitch curve of normal

curve is based on hovering, as a certain engine rpm to adjust the pitch to the best place. Stunt pitch curve is maintaining a certain engine rpm, make the pitch with the throttle to complete stunts in flying.

●Settings

Pitch curve with the throttle stick position can adjusted the engine rpm flight in the best state, This pitch curve can be set normal, stunt and lock curve and so on. The operation of those curve can carried out by the switch. Pitch curve of normal

curve is based on hovering, as a certain engine rpm to adjust the pitch to the best place. Stunt pitch curve is maintaining a certain engine rpm, make the pitch with the throttle to complete stunts in flying.

9. Throttle Cut Settings

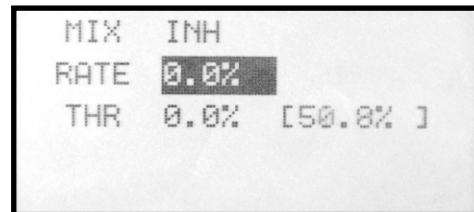
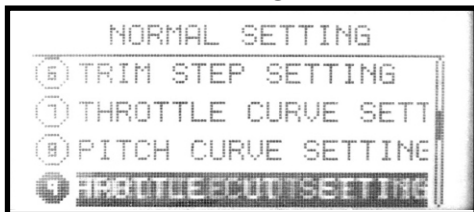

●Function

Throttle cut settings function is to make the engine off when the flight finished. Switch K1 is for opening and closing the throttle. Throttle trim adjustment will affect the throttle closed position

when implement the action. So when moving the throttle trim, have to check the throttle closed action position.

⚠Warning:

Settings and Notes: When the throttle closed switch move to open, can adjust the value until the carburetor valve fully closed (engine shutdown). To prevent the error in the adjustment operation,

the throttle turn off the function of the best range of motion is to set near the engine speed.

●Settings

In the "Preferences" interface, use Up / Down keys to select the "throttle cut settings", press OK key to confirm enter the function interface, as above. The steps of settings is as follows:
1, the first to use the arrow keys to select Edit Item 2. Throttle cut settings function on or off with

a + / - key to implement. 3. Under the throttle cut condition, the rate of value and trim amount can settings with + / - key to the implement (adjustable range of ± 45%). 4. Set successfully, press EXIT key to return.

10. Throttle holding Settings

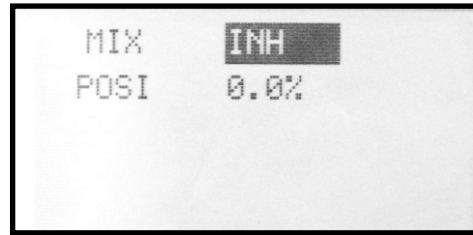
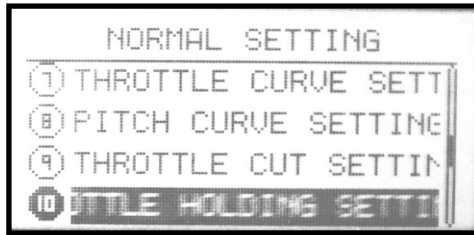

●Function

Throttle holding settings can set in when throttle cut landing, fixed the throttle servo in the a low speed position, throttle holding position can be

adjustment within $\pm 75\%$.
Switch K1 work for this function.

●Settings

In the "Preferences" interface, use Up / Down keys to select the "throttle holding settings", press OK key to confirm enter the function interface, as above. The steps of settings is as follows: 1. the first to use the arrow keys to select Edited Item. 2. In the "mixing" item to set on or off this mixing

function, with + / - keys to implement. 3. In the "Location" item to set the throttle holding location, with a + / - key to implement. Long press OK key to restore the default values. 4. Set successfully, press EXIT key to return.

11. Timer

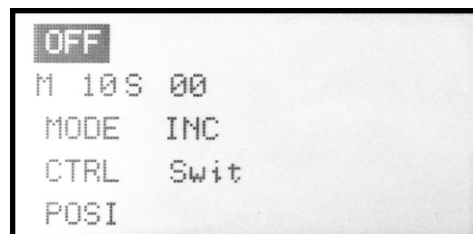
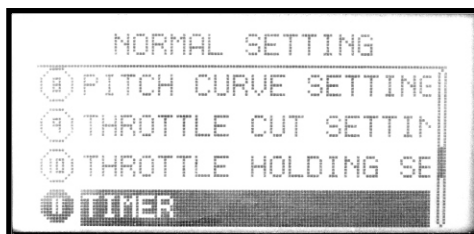

●Function

As the different of each Helicopter fuel tank size and engine speed, will lead to vary different flight time. The Timer function can alert you in warning tone landed the plane safely on the ground before you used up the fuel.

◆ The maximum time of the timer is 99 minutes and 59 seconds. In the work every 1 minute to tips time, from 20 seconds to the time, each second

alert with short-ring, when from 10 seconds to the time, each second alert with long-ring, regular arrival will blew tips.

◆ can set the timing and countdown.

◆ Control way: K2 switch control, throttle control, automatic work after boot.

●Settings

In the "Preferences" interface, use Up / Down keys to select the "Timer", press OK key to confirm enter the function interface, as above. The steps of settings is as follows:

1. First to use the arrow keys to select Edited Item.
2. In the "Timer" item set the timer.
3. In the "minutes ..seconds .." option to set the time, with a + / - key to implement. Long press OK

key to restore the default value.

4. In the "mode" item set mode. With a + / - key to implement.

5. In the "Control" item set the control switch, with + / - key to implement.

6. In the "position" item set the throttle control location. With a + / - key to implement.

7. Set successfully, press EXIT key to return.

12.Swash

Swash type selection

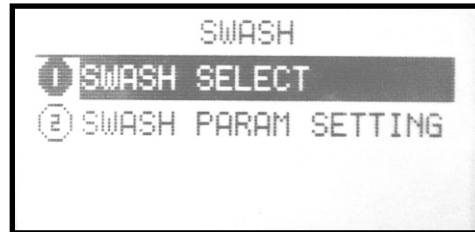
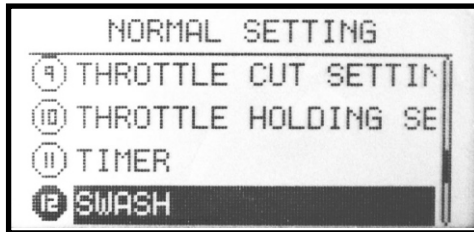

●Function

If using a helicopter with CCPM, connecting a cross-shaped piece of servo will automatic going the mixing action. Please use the helicopter swash according to the type of choice. This

remote control device offers two modes: normal, and 3CH120 (CCPM) mode. As above

●Settings

In the "Preferences" interface, use Up / Down keys to select the "Swash", press OK key to confirm enter the "Swash type selection" interface, as above.

The steps of settings is as follows:

1. First to use the arrow keys to select the Swash,

press OK key to enter.

2. Selected swash type selection press OK key to enter, with + / - key to implement the selection mode.
- 3.. Set successfully, press EXIT key to return.

Swash Parameter adjustment

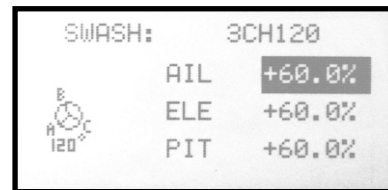
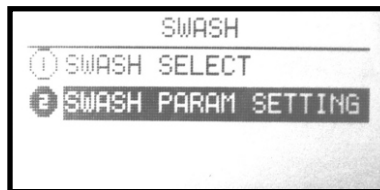
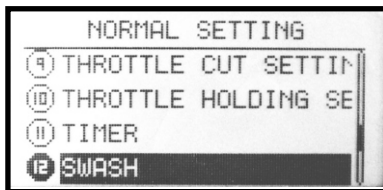

●Function

Swash parameter adjustment function is selected the swash type for adaptation the aileron elevator,

pitch three parts .

●Settings

In the "Preferences" interface, use Up / Down keys to select the "Swash", press OK key to confirm enter the "Swash type Adjustment" interface, as above.

The steps of settings is as follows: 1. First to use the arrow keys to select the Swash, press OK key

to enter.

2. Selected the swash parameter adjution press OK key to enter, with Up/down key to implement the selection. use + / - Key to adjust the parameters.
- 3.. Set successfully, press EXIT key to return.

13. Gyro Sens Mixing

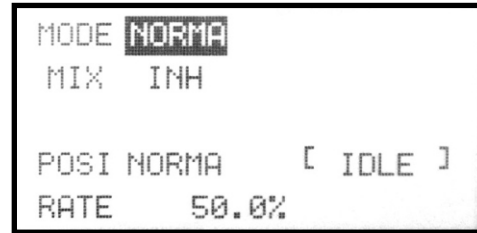

●Function

Can adjust the gyro sensitivity directly from the transmitter, you can choose AVCS gyro (GY) and ordinary gyro (STD). Gyroscope sensitivity switch plugs into the 5 channel of the receiver. This time

5channel in front of the auxiliary channel setting is temporarily non-functional,switch sensitivity by flight mode (Normal stunt lock) .

●Settings

Into the "Preferences" under the "Advanced Settings" menu,use Up / Down keys to select the gyro sens mixing "function , press the OK key to enter the function interface. As above. Specific settings steps are as follows:1. First to use arrow keys to enter the edit mode.
2. In the "mode" option set flight mode, With a + / - key to implement.
3. In the "mixing" options settings on or off this

function, use + / - key to implement. Long press OK key to restore default.
4. In the "position" option to set the control position on or off this function, with a + / - key to implement.
5. In the "ratio" option set the mixing value, with + / - key to implement. Long press OK key to restore the default value.
4. Set successfully, press EXIT key to return.

14. Advanced Settings

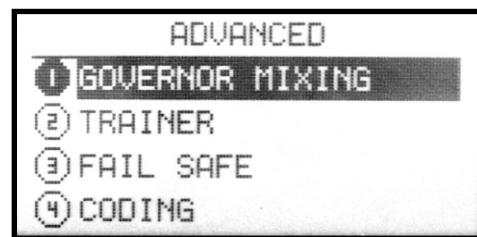
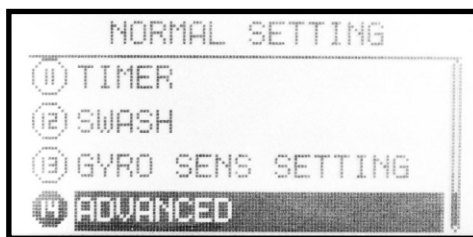

●Function

This machine for allowing users to achieve more satisfactory flight effect, added some special features in the "Advanced Settings" function.

Interface as shown. The purpose of each function will be introduced in the following

●Settings

In the "Preferences" interface,use Up / Down keys to select "Advanced Settings" and press OK key to enter the function interface, as above. In this state, press left and right arrow keys can

turn the pages, press the + / - keys to select the function item. The specific function and setting method. Please refer below.

Introduction of Advanced Setting Menu

1. Speeder Mixing Settings

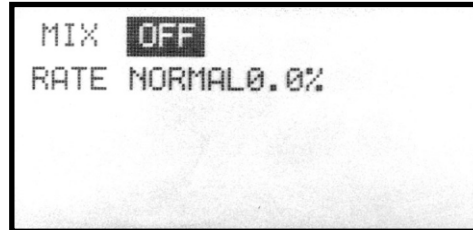
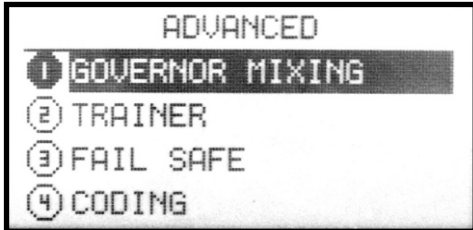

●Function

Speeder mixing settings is under the case have the speeder, uses and settings the speeder . In the

state can set the output action servo.

●Settings

Into the "Preferences" under the Advanced Settings "menu.use Up / Down keys to select the" Speeder mixing settings ", press the OK key to confirm enter the interface. The steps of settings is as follows:

1. First to use the arrow keys to enter the edit mode.

2. In the "mixing" option to set the on/off of the mixing functions, with + / - key to implement.
3. In the "ratio" option set the mixing value, with + / - key to implement. Long press OK key to restore the default value.
4. Set successfully, press EXIT key to return.

2.Fail Safe

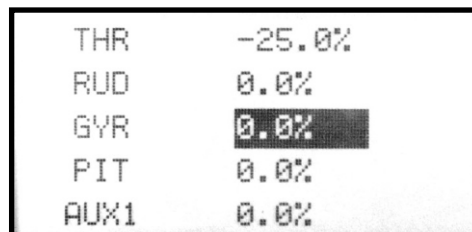
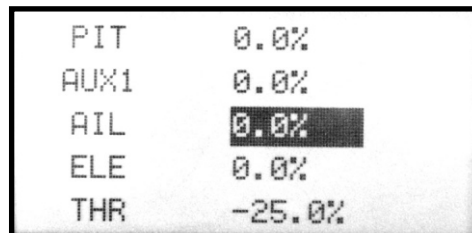
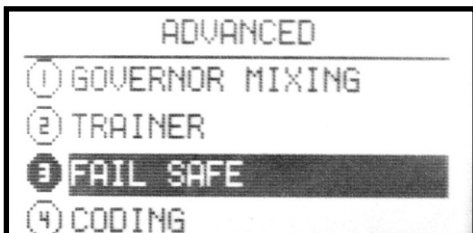

●Function

Fail safe function is used for various reasons (such as interference,long distance), the receiver will lost the transmitter signal,and the receiver will

automatically return to the default values position or maintain the current value of the function.

●Settings

Press the MENU key to boot into the "Preferences" menu, use Up / Down keys to choose "Fail safe" and press OK key to enter the function interface, as above . Can not use this feature when the 2.4 G module in close state.

The steps of settings is as follows:

1.First to use the arrow keys to select the edited

item .

2. With a + / - key to maintain the settings / specific position.
3. Click OK key, can be deposited the current actual channel parameters.
4. Set successfully, press EXIT key to return.

⚠ Warning :

When using this feature, please ensure that no

operation of other remote control!

3.Code Match

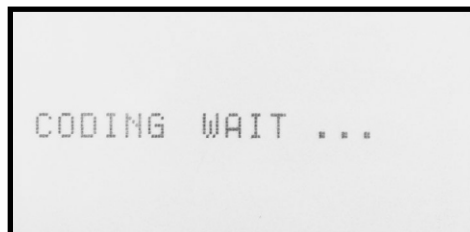
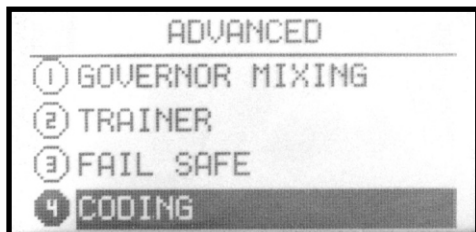

●Function

This remote control are the 2.4G spread spectrum, frequency hopping systems, with a high anti-interference. Each remote control only has an

identification code information, before you use the remote control system pls matched with the 2.4G receiver which including in this device.

●Settings

Into the "Preferences" under "Advanced settings" menu. Press OK key to enter the "Code "interface under the "Advanced Settings" . As above. Specific settings following these steps:
1. First to use the arrow keys to select the" code",

the process of the code needed within a short distance. 2.4G module system in the closed state is not available, please refer to "modulation type." Once the code successfully will initiative to return to the menu. also can press "exit" Key to Quit.



Warning

When using this feature, please ensure that no

operation of other remote control!

Airplane Function

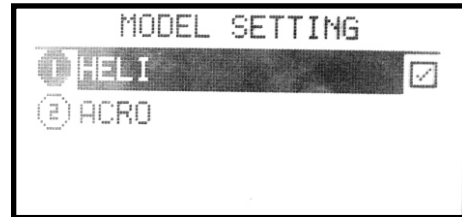
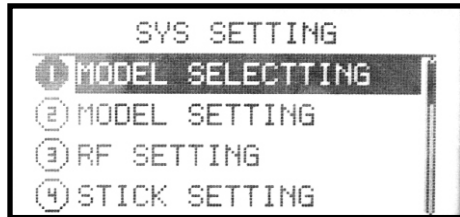

Introduction

This section are mainly introduces the airplane functions. Please press the MENU key to boot, you can enter the "System settings" item, use Up / Down keys to select "Model Settings", press the OK key to enter the function interface, (as

Shown). Please choose the model, re-boot, the transmitter can display the functions of airplane. Following description the details of each function.

Input mode and Functions

1. The main interface

When the power switch turned ON, the interface as shown. In this state, the user can view the

Voltage, Time, Models and Aileron, Throttle, Elevator, Rudder and other state

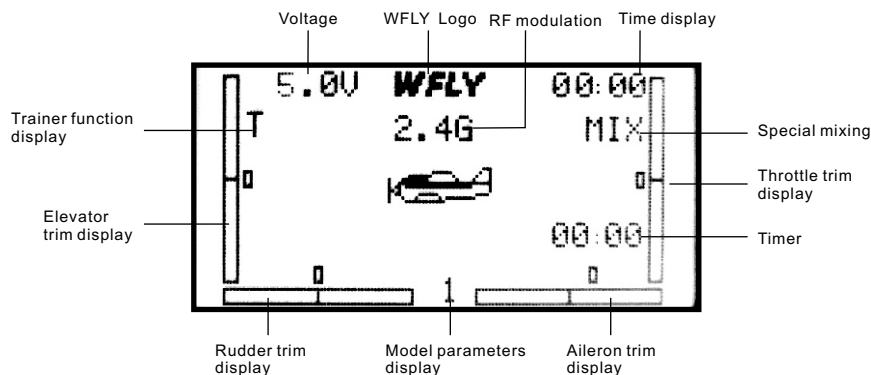

2. Function Menu Selection refer the instructions on page 12

Introduction of System Settings Menu▲

- 1.Model parameters Selection Refer the introduction on page 13
- 2.Model Setting Selection Refer the introduction on page 13
- 3.Coaching / Simulation Selection Refer the introduction on page 13
- 4.Stick settings Selection Refer the introduction on page 14
- 5.Stick calibration Selection Refer the introduction on page 14
- 6.Restore factory settings Selection Refer the introduction on page 15
- 7.Tone settings Selection Refer the introduction on page 15
- 8.Contrast settings Selection Refer the introduction on page 15
- 9.Power supply scheme Selection Refer the introduction on page 16
- 10.Version Information Selection Refer the introduction on page 16

Introduction of Parameter Settings Menu▲

- 1 Monitor Selection Refer the introduction on page 17
- 2 Dual rate Selection Refer the introduction on page 17
- 3 Servo reverse Selection Refer the introduction on page 18
- 4 End point Selection Refer the introduction on page 18
- 5 Sub trim Selection Refer the introduction on page 19
- 6 Trim Selection Refer the introduction on page 19
- 7.Flaperon mixing

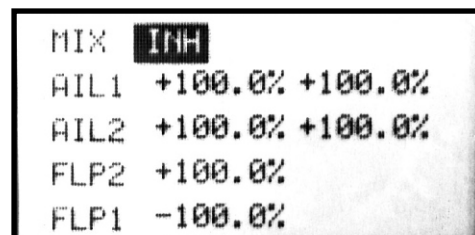
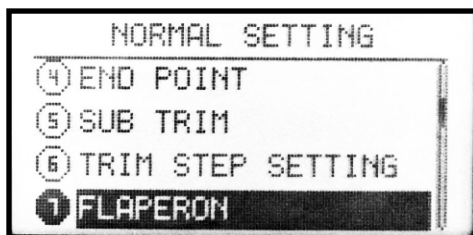

●Function

This feature is to use two mixers in the aileron, to

make aileron have a mixer like flap function.

●Settings

Press the power button to boot into the "Preferences" menu, use Up / Down arrow to select the "Flaperon mixing", press OK key to enter the function interface, as above.

The steps of settings is as follows: 1. Using the up

/ down keys can choose to the edit item.

2. Selected the options, press the + / - key to edit the data. Long press OK key to restore the default values.

3. Set successfully, press EXIT key to retrun.

8 Flap trim

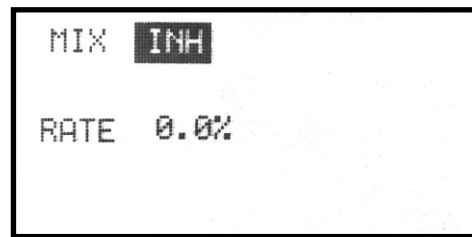

●Function

This feature is for 6 channels to do the trim stick

action.

●Settings

Press the power key to boot into the "parameter settings" menu, use Up / Down keys to select the "Flap trim", press OK key to enter the function interface, as above. The steps of settings is as follows:

item.

1. Using the up / down keys can choose to the edit

2. Selected the options, press the + / - key to edit the data. Long press OK key to restore the default values.

3. Set successfully, press EXIT key to return.

9 Aileron diff control

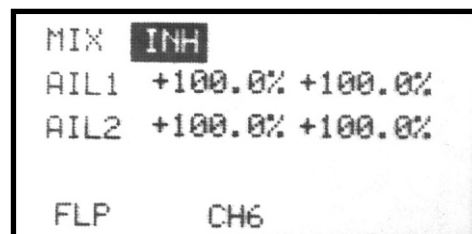
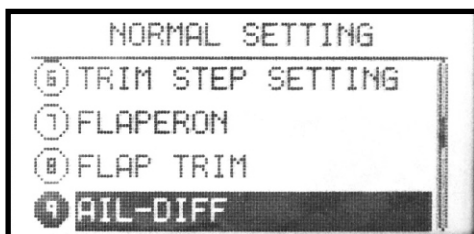

●Function

This feature is used in have two aileron servo, you

can create the differential aileron movement.

●Settings

Press the power button to boot into the "parameter settings" menu, use Up / Down keys to select the "Aileron diff control", press OK key to enter the function interface, as above. The step of settings is as follows:

1. Use the up / down key to select the Edit Item
2. Selected the options, press the + / - key to edit the data. Long press OK kry to restore the default value.
3. Set successfully, press EXIT key to return.

10 Ele-Flap Mixing

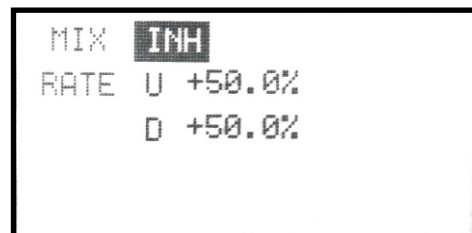
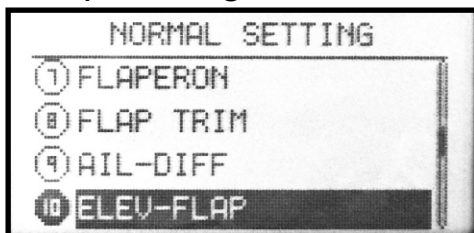

●Function

This feature is to make the flap, elevator doing the corresponding action. Flap down, elevator up,

make the stunt movement more fluid . K2 controls the switch.

●Settings

Press the power button to boot into the "Parameter setting" menu, use Up / Down keys to select the "Ele-flap mixing", press OK key to enter the function interface. As above.

The step of settings is as follows:

1. Using the up / down keys to choose the edit item.
2. Selected the options, press the + / - key to edit the data. Long press OK key to restore the default values.
4. Set successfully, press EXIT key to return.

- 11 Throttle Curve Settings Selection Refer the introduction on page 19
- 12 Throttle Cut Settings Selection Refer the introduction on page 20
- 13 Throttle Holding Settings Selection Refer the introduction on page 21
- 14 Timer Selection Refer the introduction on page 21

Advanced Settings Menu ▲

1. Elevator Mixing

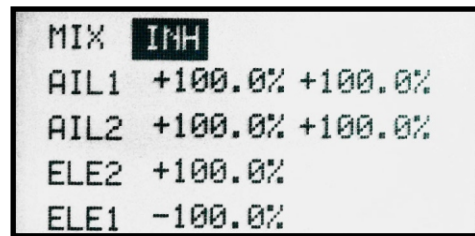
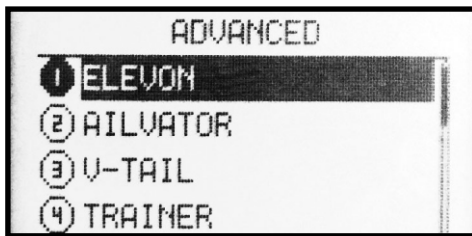

●Function

This feature is generally applicable to the Elevon mixed by aileron and elevator, Can adjust the

aileron, elevator action volume independently.

⚠ Notes:

The three of Elevon, V tail, elevator function can not be open simultaneously. Also Ele --Aileron, flaps, aileron diff is also only can use one function, can not be open when the other functions working, this feature will show " warning "Please forbid the other mixing, and then turn on this feature. As shown on the right

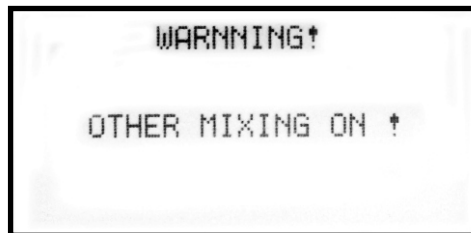

●Settings

Into the "Preference Settings" under "Advanced Settings" menu, use up / down keys to select the "Elevator mixing", press OK key to enter the function interface, as above.

The step of settings is as follows:

1. Using the up / down keys to choose the edit item.
2. Selected the options, press the + / - key to edit the data. Long press OK key to restore the default values.
2. Set successfully, press EXIT to return.

2. Ele-Aileron Mixing

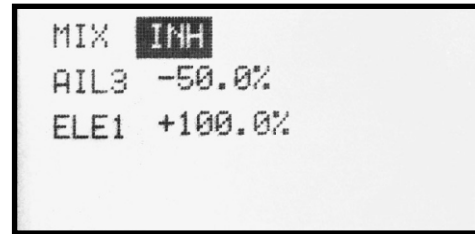
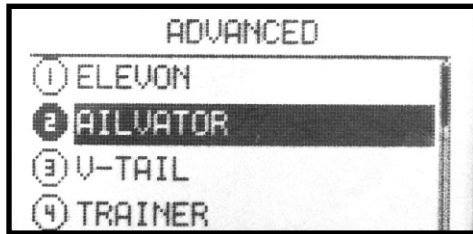

●Function

This feature is to allow elevator to work in the

aileron mixing function.



Notes:

Ele--aileron mixing, V-tail , Ele- flaps can not be opened simultaneously, if the screen displays

"warning", please forbid the other mixing functions, then turn on this function.

●Settings

Into the "Preferences settings" under "Advanced Settings" menu .use Up / Down keys to select "Ele - aileron mixing", press OK key to enter the function interface . As above.

The step of settings is as follows:

1. Using the up / down keys to choose the edit

item.

2. Selected the options, press the + / - key to edit the data. Long press OK key to restore the default values.

4. Set successfully, press EXIT key to return.

3. V-Tail Mixing

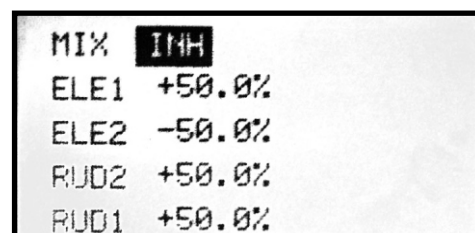
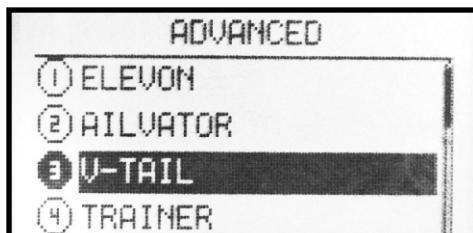

●Function

This feature is use for V-tail aircraft the elevator

and rudder mixing function.

●Settings

Into the "Preferences Settings" under "Advanced Settings" menu.use Up / Down keys to select "V-tail mixing" and press OK key to enter the function interface. As above.

The step of settings is as follows:1. Using the up /

down keys to choose the edit item.

2. Selected the options, press the + / - key to edit the data. Long press OK key to restore the default values.

3. Set successfully, press EXIT key to return.

4. Aileron-2

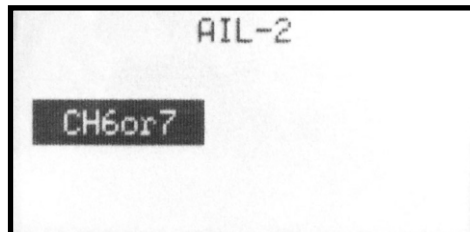
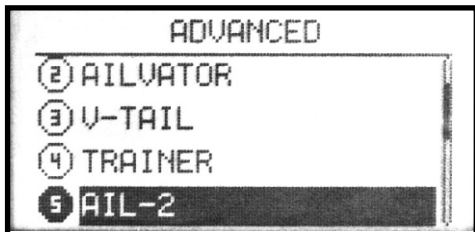

●Function

Aileron -2 is aileron another channel 's

distribution.

●Settings

Press the MENU key to boot into the "System Settings" menu, use Up / Down keys to select the "aileron -2", press the OK key to enter this function interface, as above.

The step of settings is as follows

1. Using the + / - keys to choose different models.
2. Selected the options, press OK key to confirm.
3. Set successfully, press EXIT key to return.

5 Fail Safe Selection Refer the introduction on page 24

6 Code Match

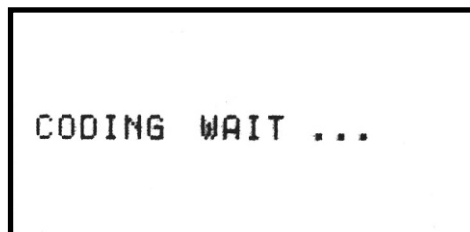
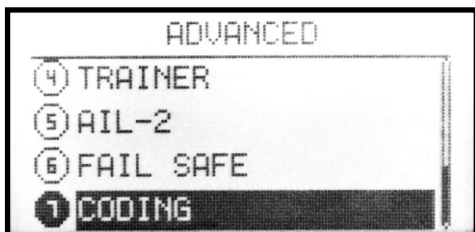

●Function

This remote control is the 2.4G spread spectrum, frequency hopping systems, with a high anti-interference. Each remote control has unique

identification code information, before you use the remote control system pls matched with the 2.4G receiver including in the device.

●Settings

Into the "Preference Settings" under "code" menu . Click OK key to enter the state of the coding. As above

The step of settings is as follows:

1. First to use the arrow keys to select on the code, the process of the code needed within a

short distance. 2.4G module system can not use this function in the closed state, please refer to "Coaching / Simulation" Once the code successfully will initiative to return the menu. Also Can press "Exit"key to quit.

⚠Warning :

When using this function, please ensure that no

other operation of remote control!

FCC WARNING

Changes or modifications not expressly approved by the party responsible for compliance could void the user's authority to operate the equipment..



SHENZHEN WFLY TECHNOLOGY DEVELOPMENT CO.,LTD

Room 618-619,6/F Chuangye Building, No.1 Qilin Road, Nanshan District, Shenzhen 518052, P.R.China
Tel: +0755-26581815 Fax: +86-755--26585126 [http:// www.wflysz.com](http://www.wflysz.com) Email: sale2@wflysz.com

Thank you for purchasing WFT07 remote control device, pls read the instructions carefully before use it.