



Zivko Edge 540 V3 - 92" wingspan 60-70cc

Code : SEA 363

ASSEMBLY MANUAL

“Graphics and specifications may change without notice”.



Specifications:

Wingspan-----	91.0 in-----	(231.0 cm)
Wing area-----	1481.5-----	sq.ins (95.6 sq.dm)
Weight-----	19.4-20.3 lbs-----	(8.8-9.2 kg)
Length-----	93.1 in -----	(236.5 cm)
Engine/Motor size-----	60-70cc gasoline	
Radio-----	6 channels with 6 servos	



INTRODUCTION

Thank you for choosing the **Zivko Edge 540 V3 - 92" wingspan 60-70cc** ARTF by **SG MODELS**. The **Zivko Edge 540 V3 - 92" wingspan 60-70cc** was designed with the intermediate/advanced sport flyer in mind. It is a semi scale airplane which is easy to fly and quick to assemble. The airframe is conventionally built using balsa, plywood to make it stronger than the average ARTF, yet the design allows the aeroplane to be kept light. You will find that most of the work has been done for you already. The motor mount has been fitted and the hinges are pre-installed. Flying the **Zivko Edge 540 V3 - 92" wingspan 60-70cc** is simply a joy.

This instruction manual is designed to help you build a great flying aeroplane. Please read this manual thoroughly before starting assembly of your **Zivko Edge 540 V3 - 92" wingspan 60-70cc**

WARNING

Please be aware that this aeroplane is not a toy and if assembled or used incorrectly it is capable of causing injury to people or property. WHEN YOU FLY THIS AEROPLANE YOU ASSUME ALL RISK & REponsibility.

If you are inexperienced with basic R/C flight we strongly recommend you contact your R/C supplier and join your local R/C model Flying Club. R/C Model Flying Clubs offer a variety of training procedures designed to help the new pilot on his way to successful R/C flight. They will also be able to advise on any insurance and safety regulations that may apply.

KIT CONTENTS



KIT CONTENTS

SEA363 Zivko Edge 540 V3 - 92"
wingspan 60-70cc

1. Fuselage
2. Wing set (2)
3. Tail set (3)
4. Cowling
5. Wing tube
6. landing gear
7. Fuel tank
8. Wing tip (2)
9. Spinner
10. Tail wheel

ADDITIONAL ITEMS REQUIRED

- 60-70cc gasoline engine.
- Computer radio 6 channel with 6 servos.
- Glow plug to suit engine.
- Propeller to suit engine.
- Protective foam rubber for radio system.

TOOLS & SUPPLIES NEEDED

- Thin cyanoacrylate glue.
- Medium cyanoacrylate glue.
- 30 minute epoxy.
- 5 minute epoxy.
- Hand or electric drill.
- Assorted drill bits.
- Modelling knife.
- Straight edge ruler.
- 2mm ball driver.
- Phillips head screwdriver.
- 220 grit sandpaper.
- 90° square or builder's triangle.
- Wire cutters.
- Masking tape & T-pins.
- Thread-lock.
- Paper towels.

INSTALL THE AILERONS CONTROL HORN

1.

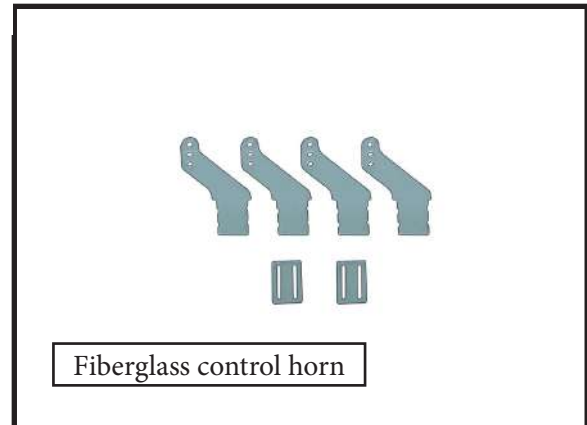

Prepare the aileron control horns by sanding the section that extends into the control surface with medium grit sand paper. Use isopropyl alcohol and a paper towel to remove any excess debris from the control horn.

2.

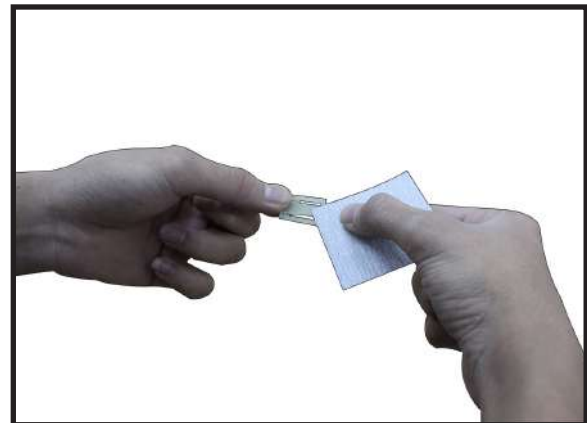

3.

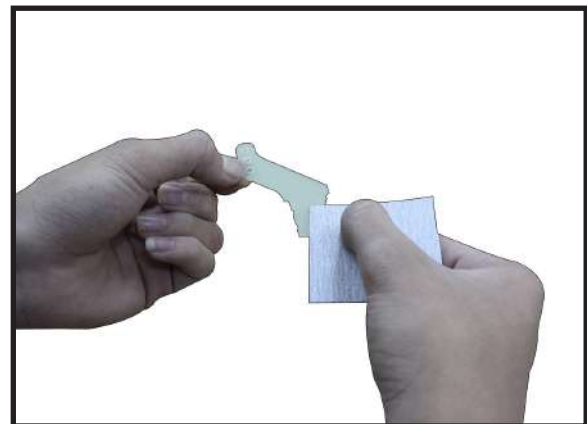

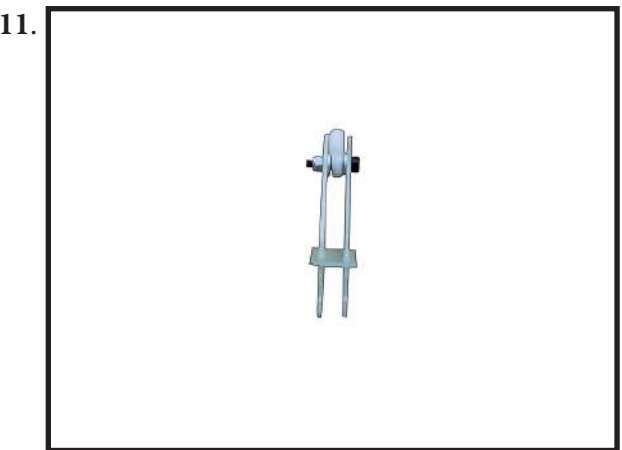
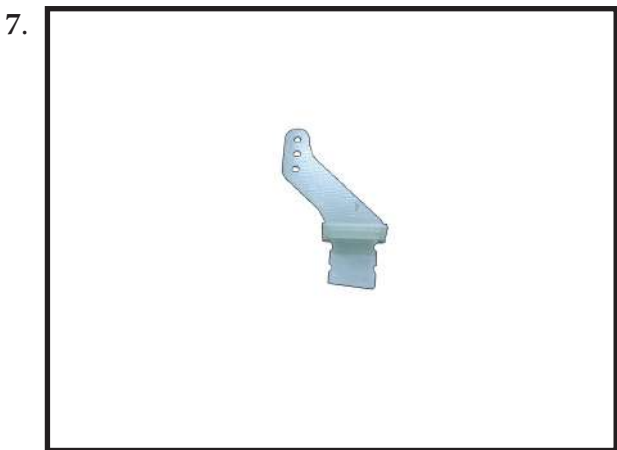
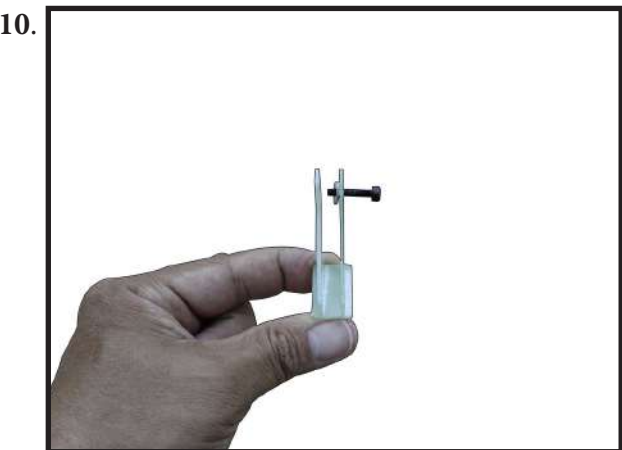
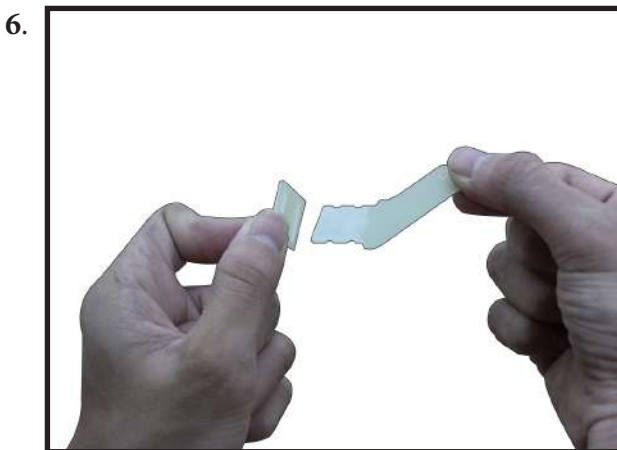
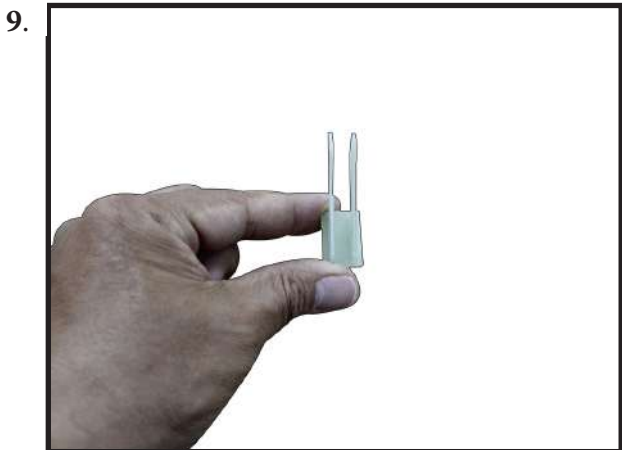
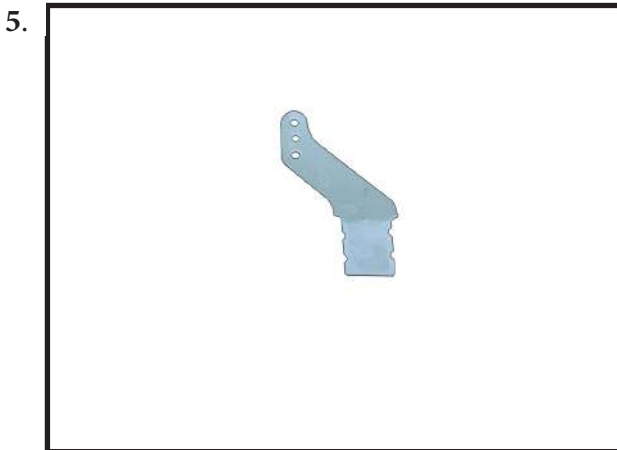
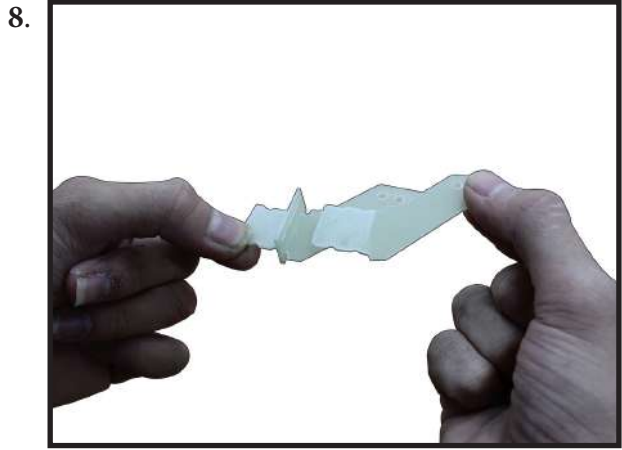
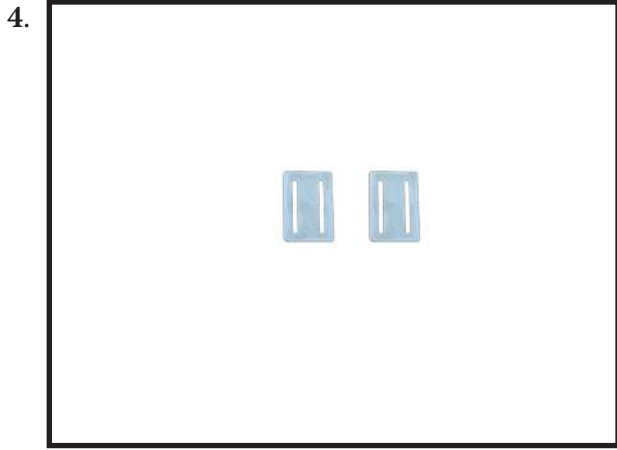

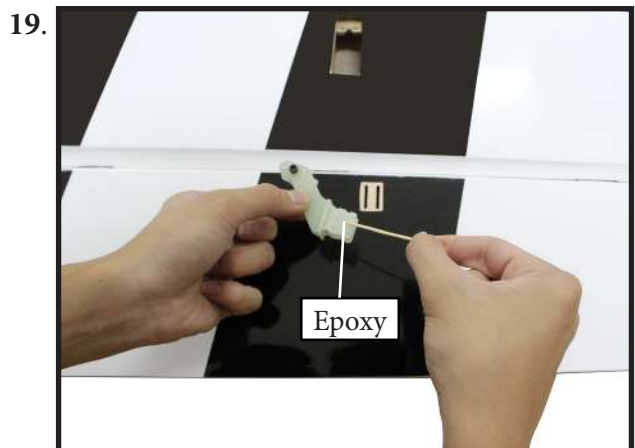
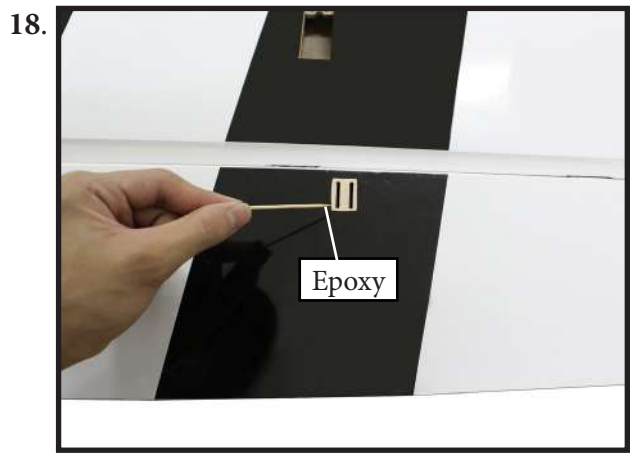
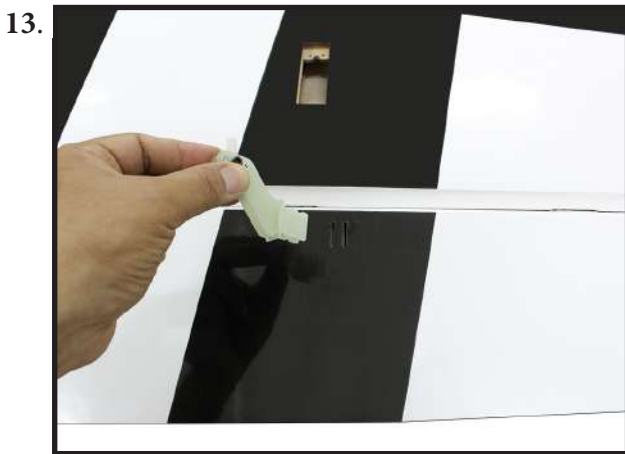
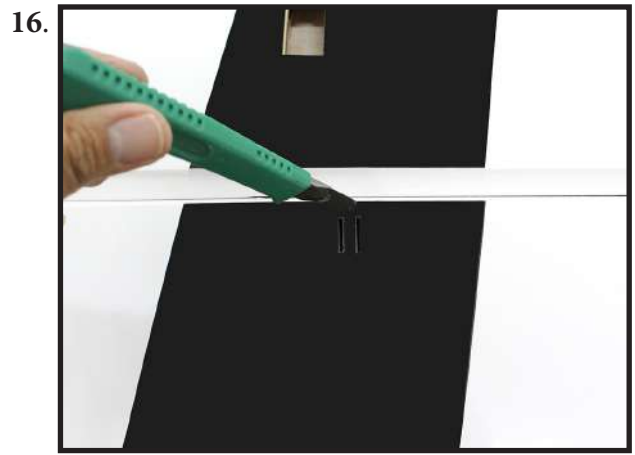

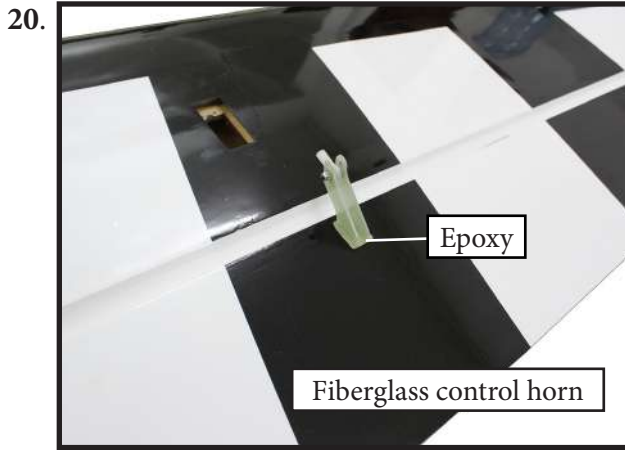

Attach the extension to the servo lead and secure with Safety Clip, safety wire, tape or other method. Ensure the plugs will not come apart from vibration or light tension.

Fasten the pull string from the servo hole to the male plug of the servo extension.

INSTALLING THE AILERON SERVOS

Please study images below.

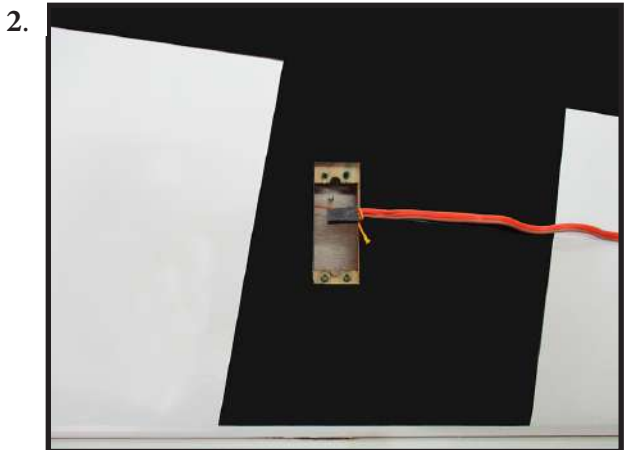
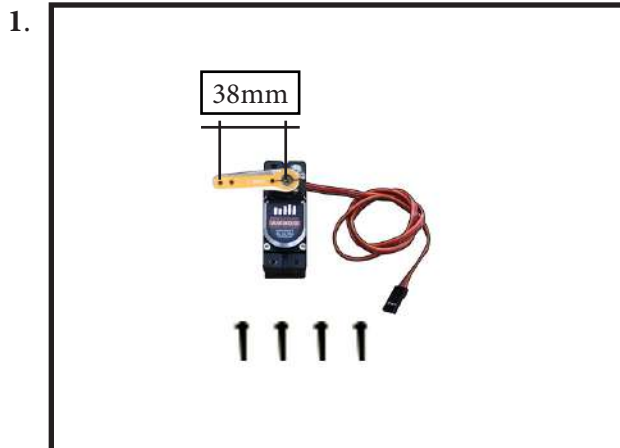

Minimum servo spec.
Torque : 27.3 kg-cm (378 oz-in) @6.0V
 33.7 kg-cm (467 oz-in) @7.4V
 38.2 kg-cm (530 oz-in) @8.4V
Transit Speed : 0.14 sec/60° @6.0V
 0.11 sec/60° @7.4V
 0.10 sec/60° @8.4V

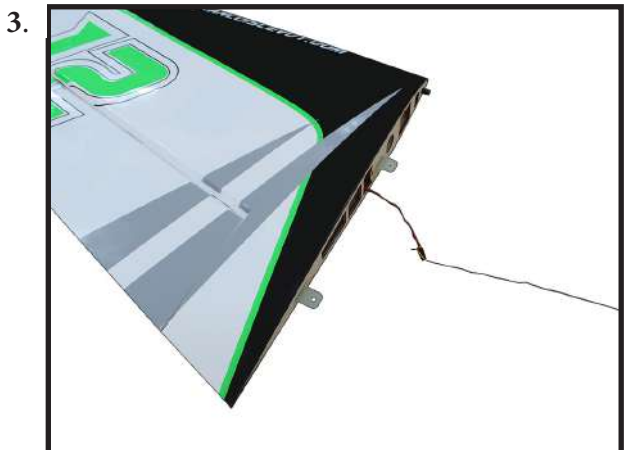

NOTE : servos arm for aileron is not provided from manufacturer.

Layout the servo on the wing to test fit the installation and ensure servo lead is the correct length.

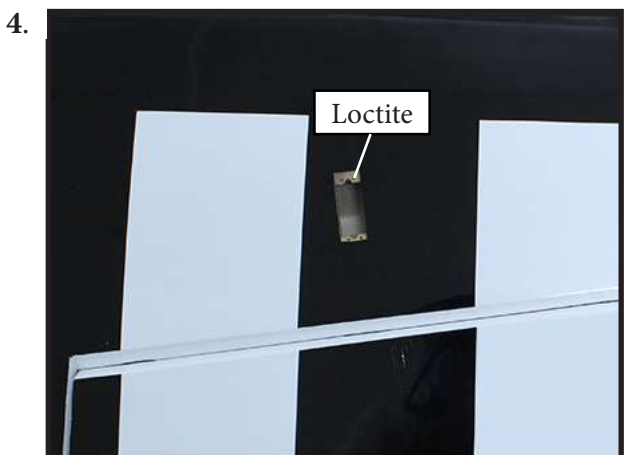

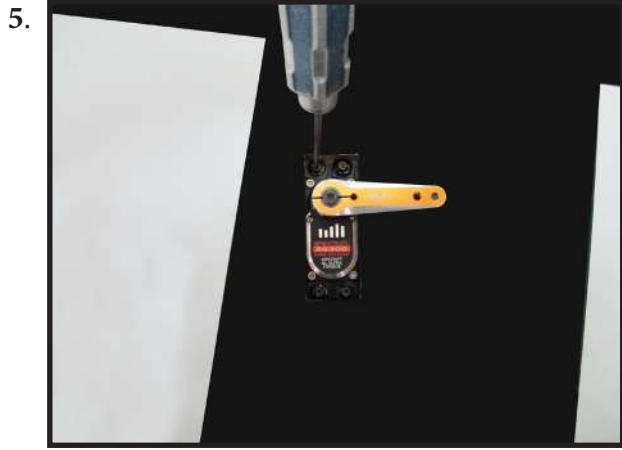

INSTALLING THE AILERON PUSHROD

Please study images below.

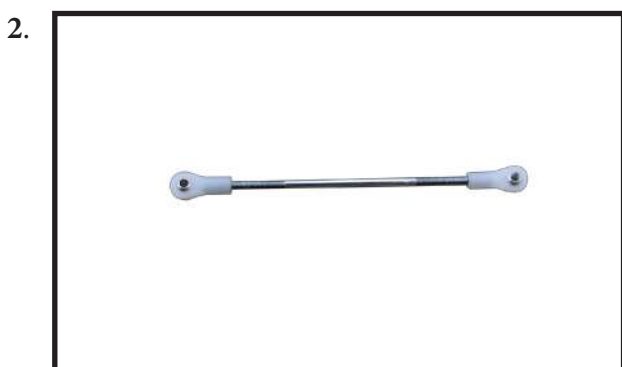
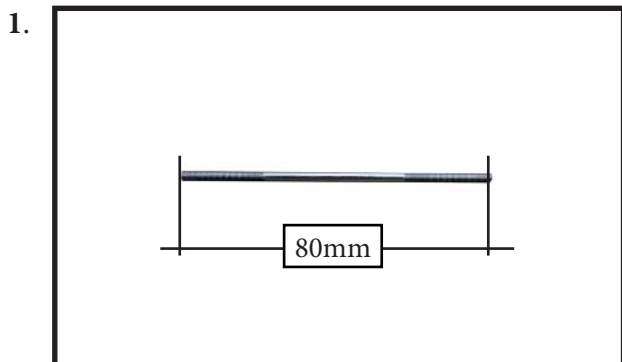

Repeat all the above steps for the other wing.



INSTALL ELEVATOR CONTROL HORN

Please study images below.

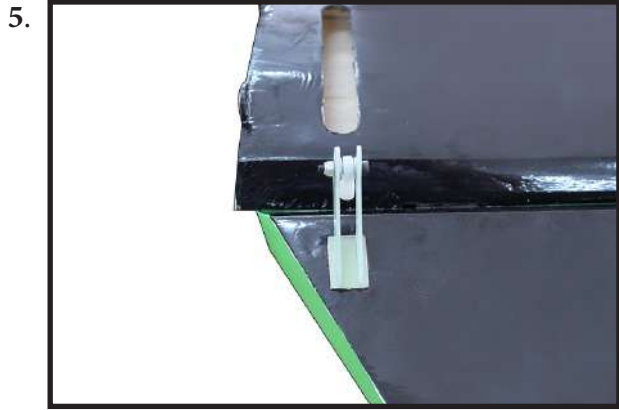
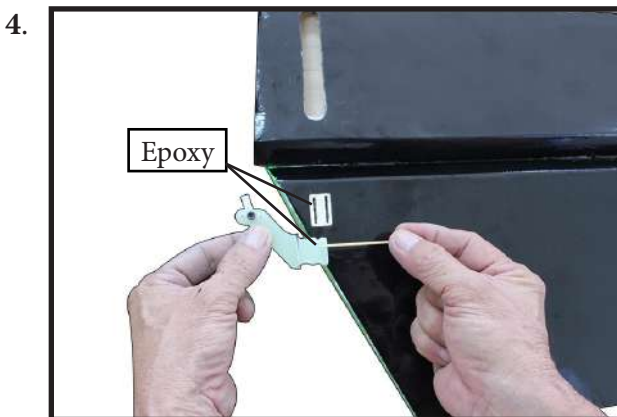
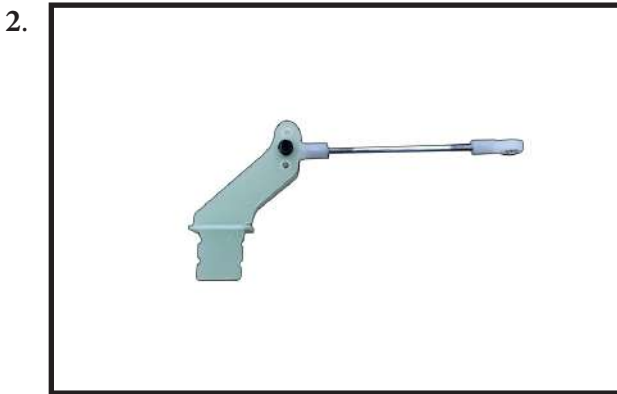
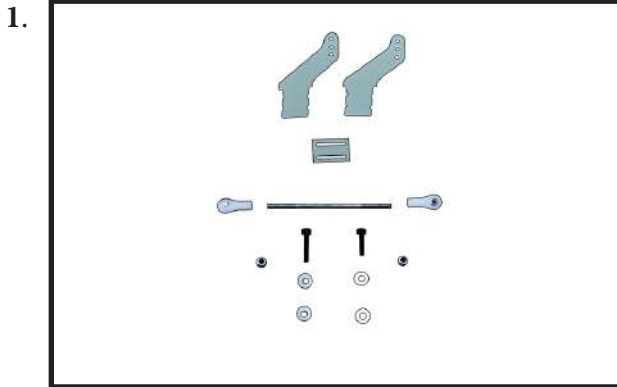

ELEVATOR SERVO INSTALLATION

The elevators have been pre-hinged and glued to the stabs and are ready for flight. No other steps are necessary for hinging.

NOTE : servos arm for elevator is not provided from manufacturer.

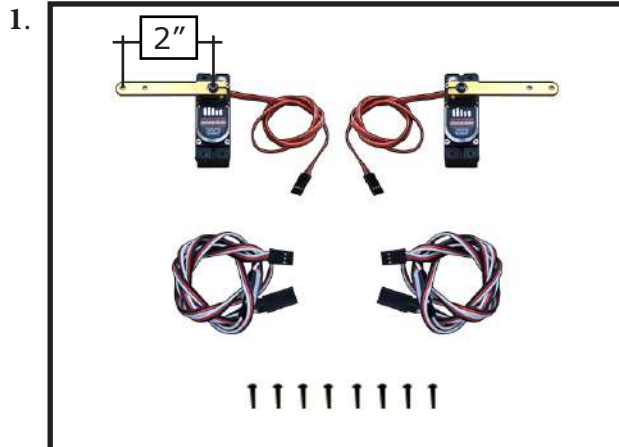

Minimum servo spec.
Torque : 27.3 kg-cm (378 oz-in) @6.0V
 33.7 kg-cm (467 oz-in) @7.4V
 38.2 kg-cm (530 oz-in) @8.4V
Transit Speed : 0.14 sec/60° @6.0V
 0.11 sec/60° @7.4V
 0.10 sec/60° @8.4V

Attach the extension to the servo lead and secure with Safety Clip, safety wire, tape or other method. Ensure the plugs will not come apart from vibration or light tension.

2.



Feed servo extension through the elevator servo mounting hole.

3.

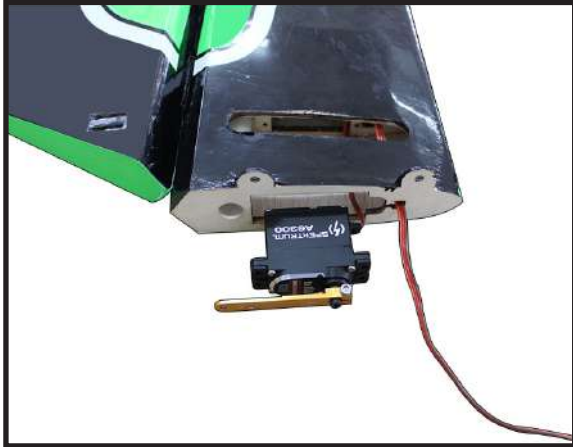

Install servo with servo mounting screws.

4.

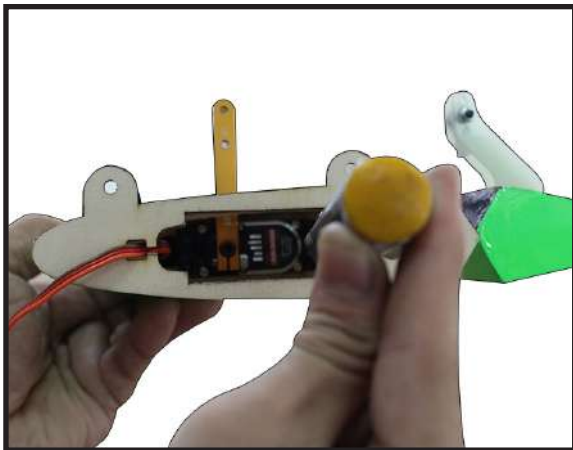

5.

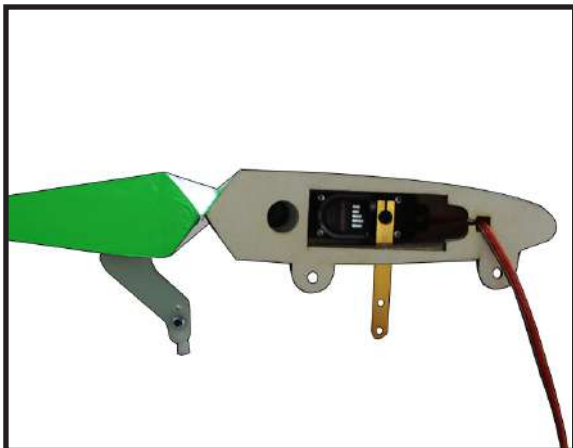

ELEVATOR PUSHROD INSTALLATION

Please study images below.

1.

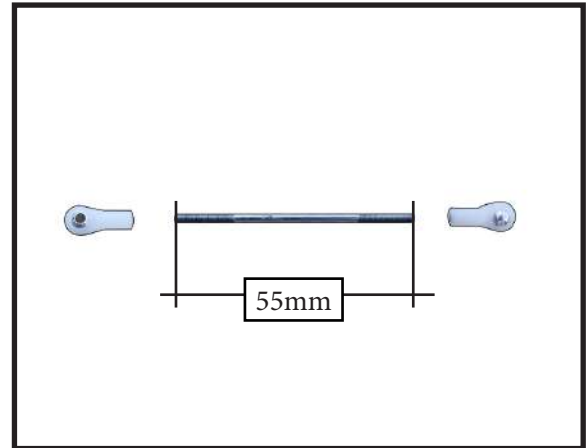

2.

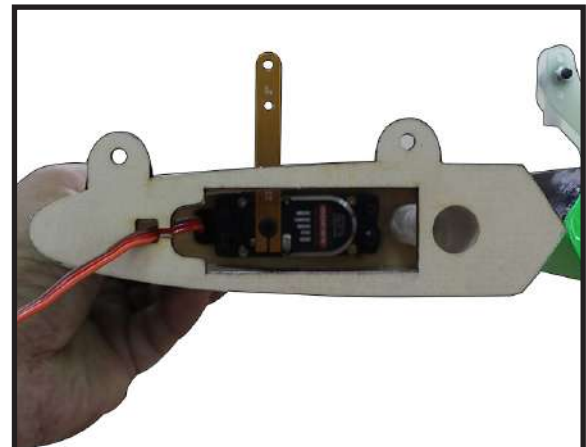

3.

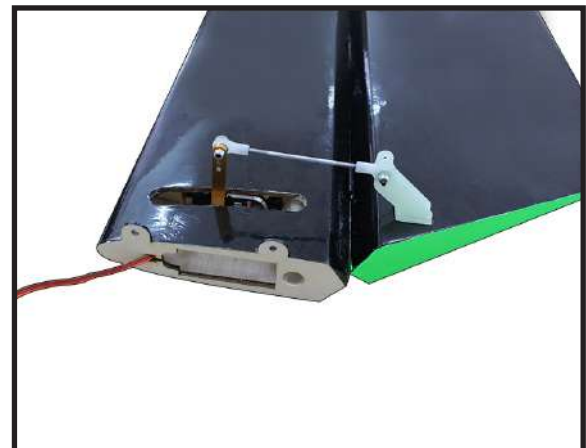

Repeat all the above steps for the other elevator.

INSTALL HINGE FOR RUDDER AND FIN

Please study images below.

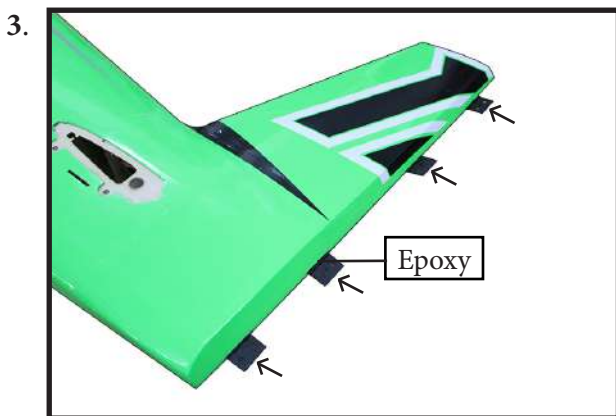
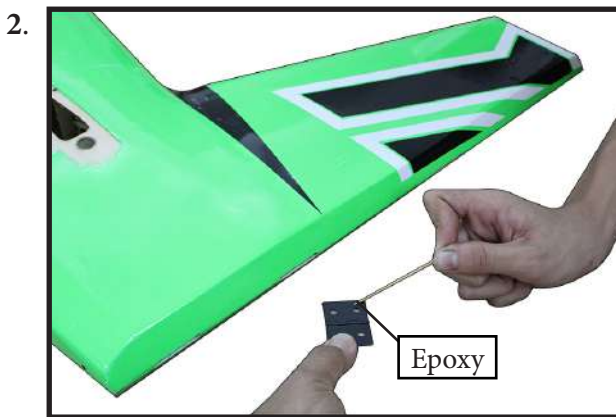
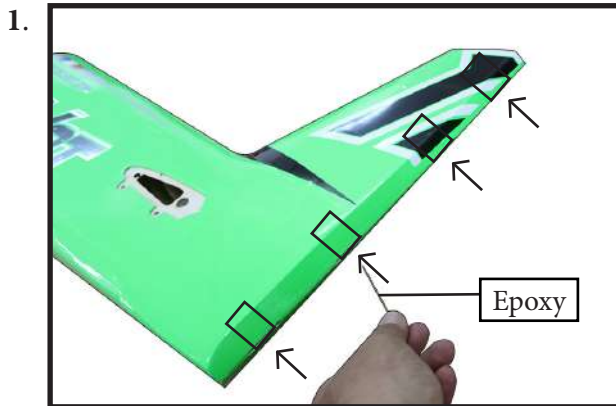

INSTALL RUDDER CONTROL HORN

You have two choices to install sevor rudder, We recommend setting the sevor rudder on the front of the fuselage when using 61cc engines and setting the sevor on the rear of the fuselage when using the DA70cc or GP76cc engines, this will help balance the CG better.

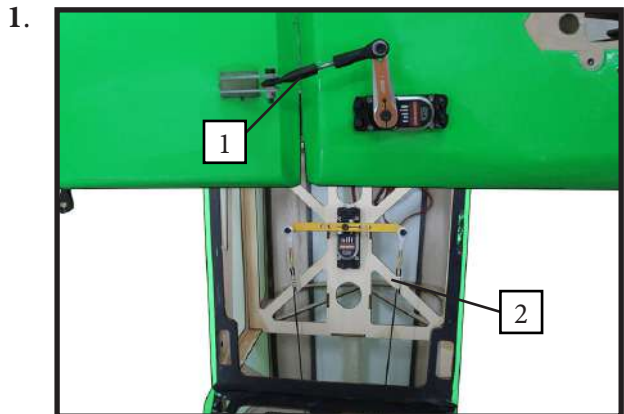

Minimum servo spec.
Torque : 27.3 kg-cm (378 oz-in) @6.0V
 33.7 kg-cm (467 oz-in) @7.4V
 38.2 kg-cm (530 oz-in) @8.4V
Transit Speed : 0.14 sec/60° @6.0V
 0.11 sec/60° @7.4V
 0.10 sec/60° @8.4V

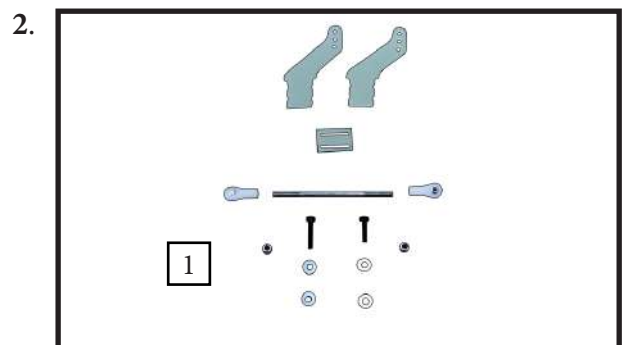

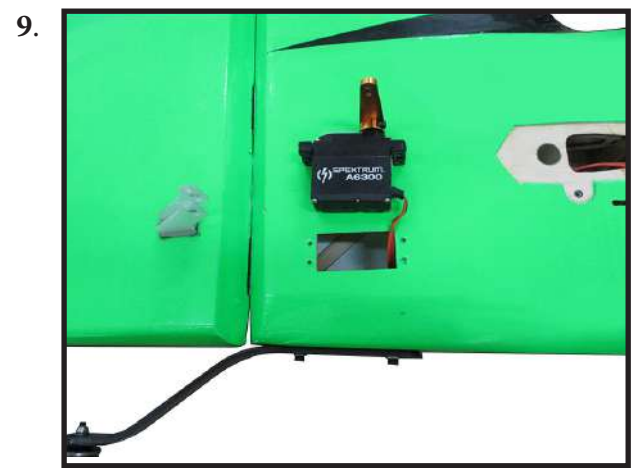
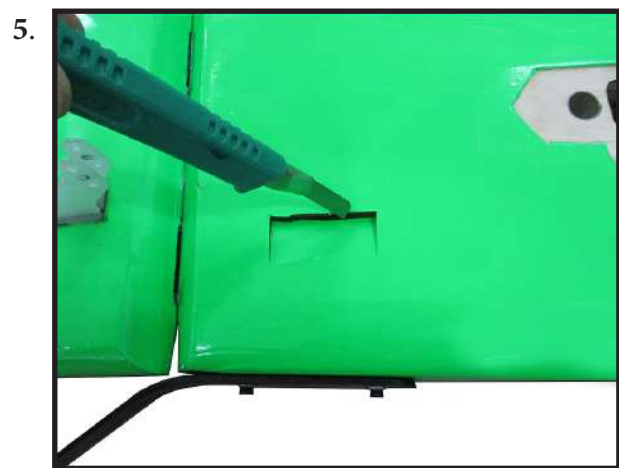
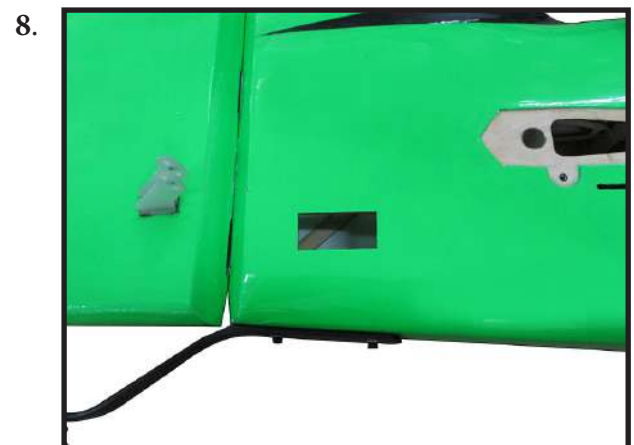
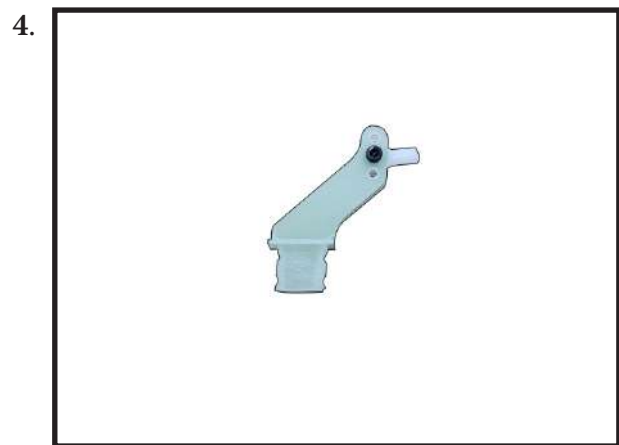
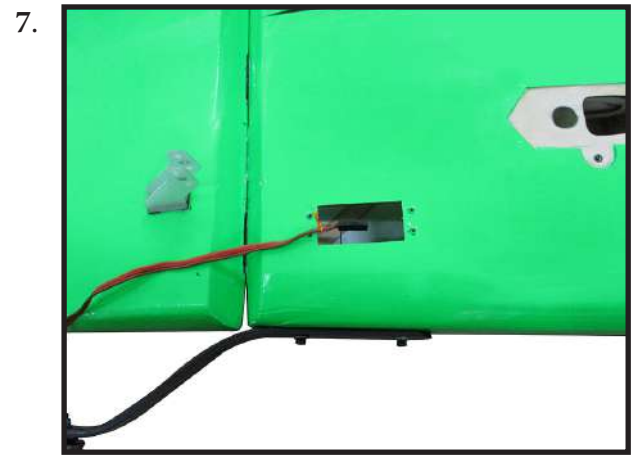
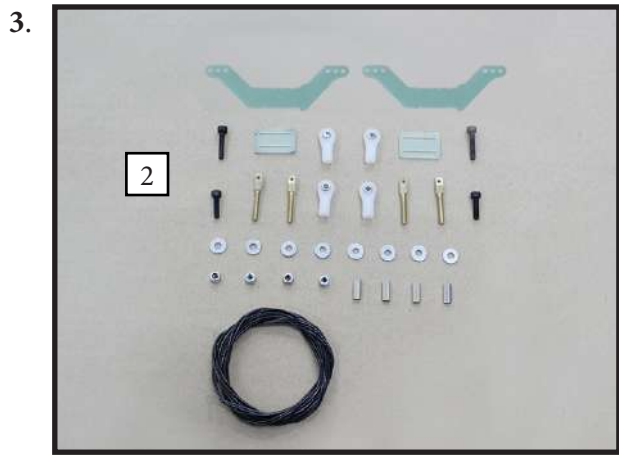

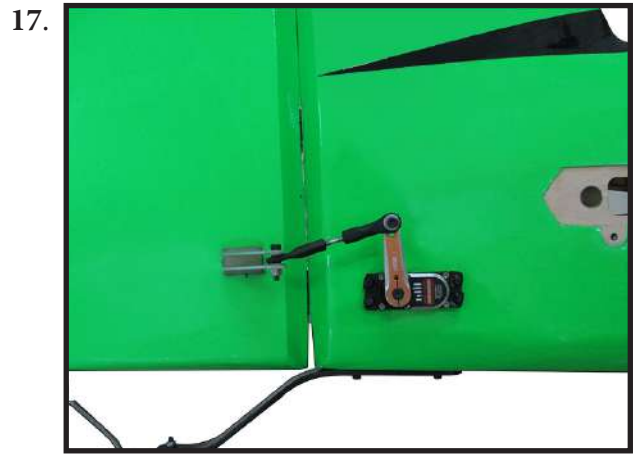
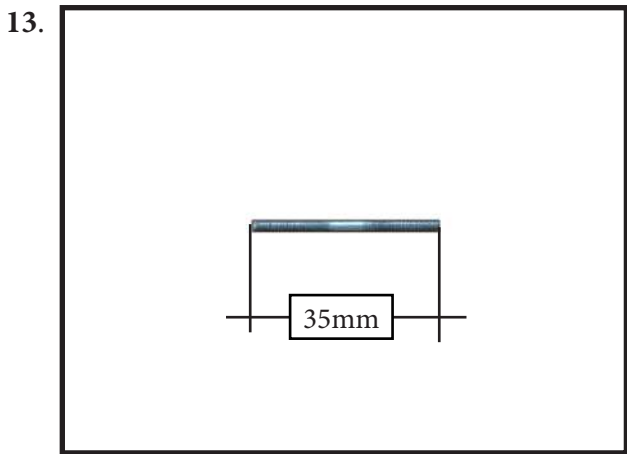
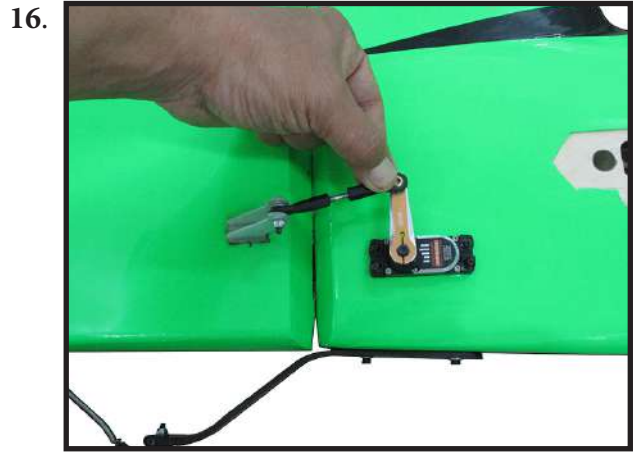
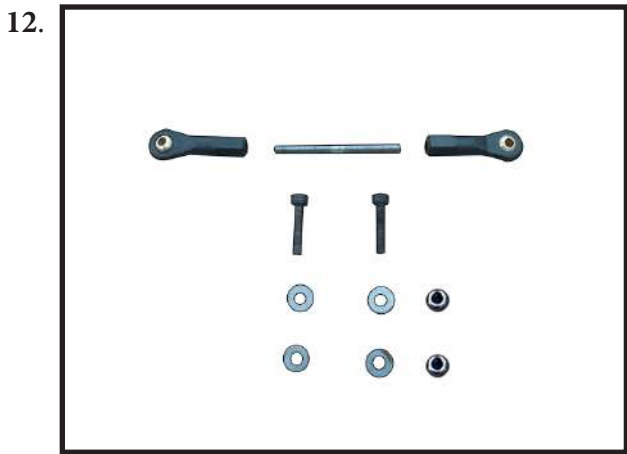
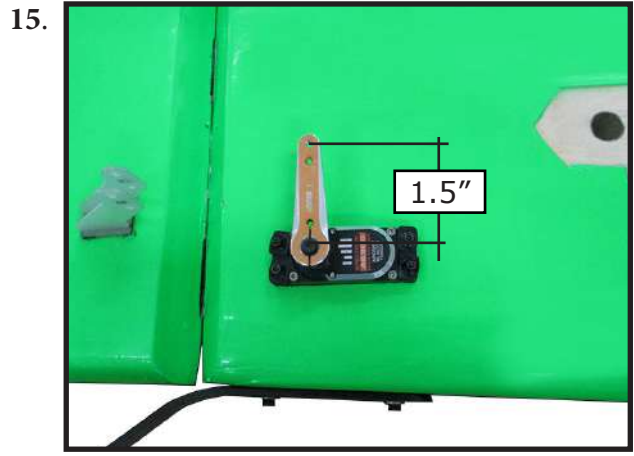

19.

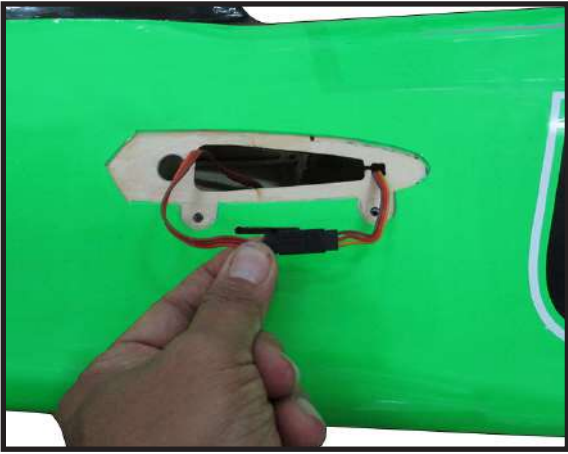

INSTALL RUDDER CABLE AND SEVO

Gather one rudder servo, mounting screws, servo arm and the rudder control linkage parts shown below.

NOTE : servos arm is not provided from manufacturer.

20.



1.

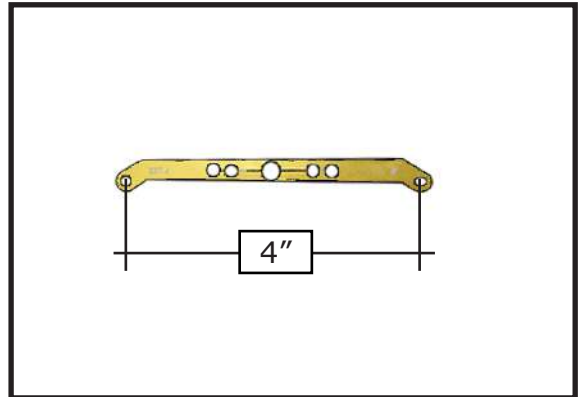

2.

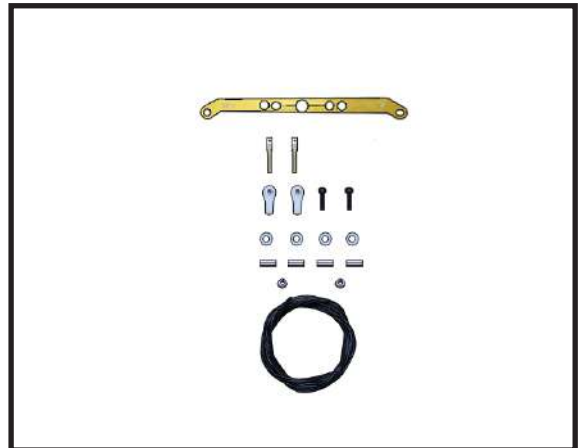

21.

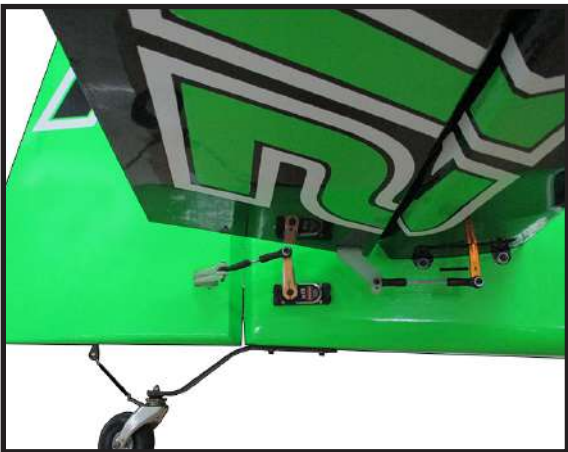

Tape the rudder balance tab to the top leading edge of the vertical fin in the neutral position as shown. This ensures the rudder is straight when the cables are attached.

22.



3.



Thread the rudder cable through a brass swage tube, then the threaded coupler, and back through the brass swage tube on both sides. Pull light tension on the cable through the coupler on both sides as shown.

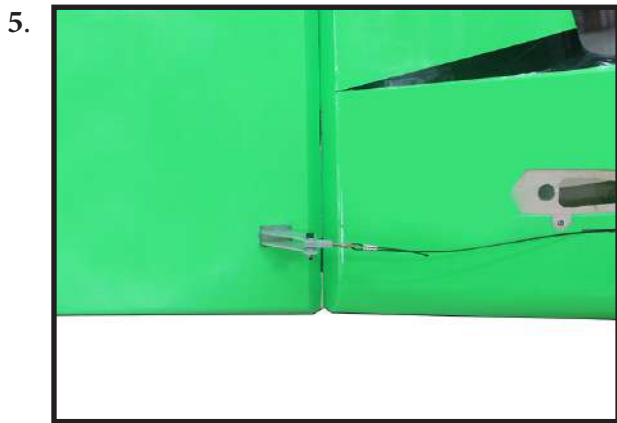
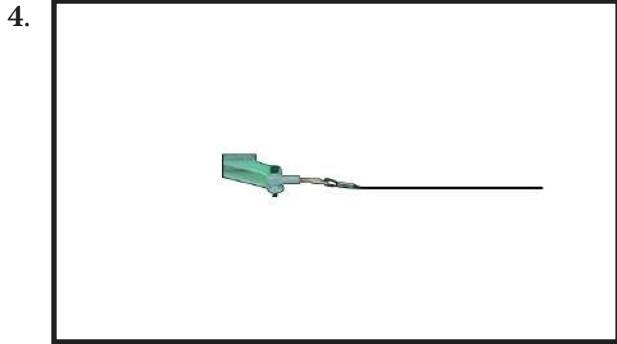

Loop the cable back through the brass swage tube and tighten the second loop through the brass swage tube as shown.



Crimp the brass tube with a crimping tool or pliers.

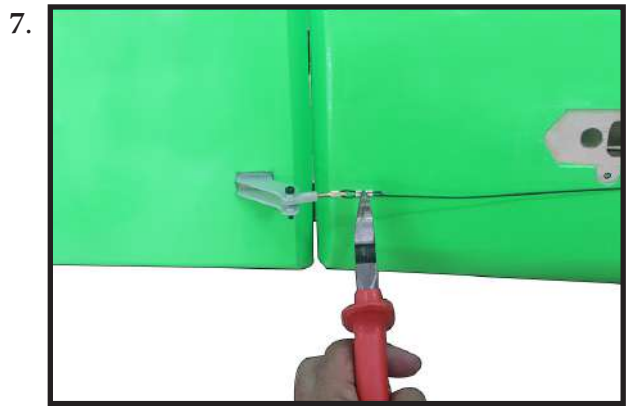

Cut off excess cable as shown.

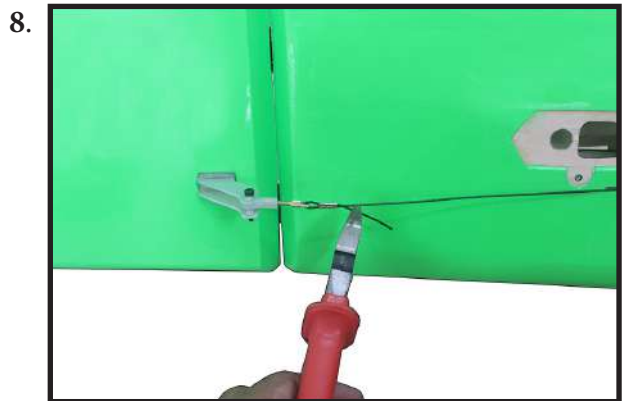

Feed one rudder cable through the pre installed cable exit tube in the rear of the fuse toward the front of the fuse. Repeat for other side.

11.

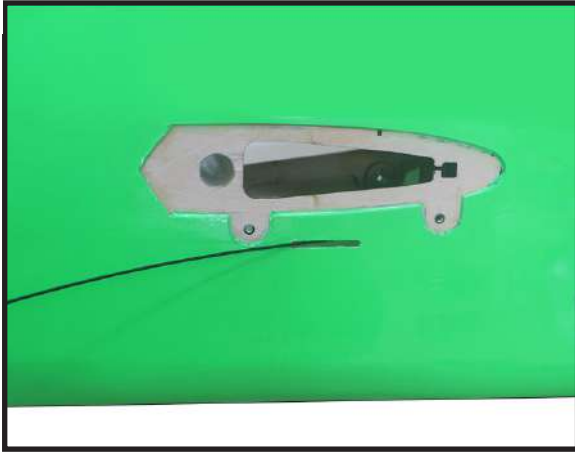

Thread cable through brass swage tube.

12.



Thread cable through the threaded hole, and back through the brass swage tube as shown.

Loop the cable back through the brass swage tube and pull tight.

13.

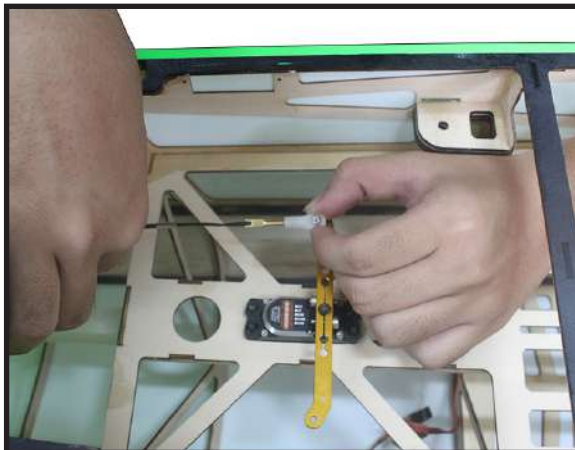

14.

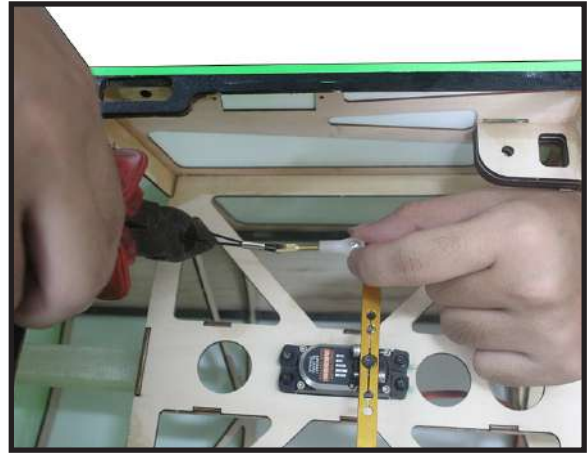

Crimp the brass swage tube with a crimping tool or pliers.

15.

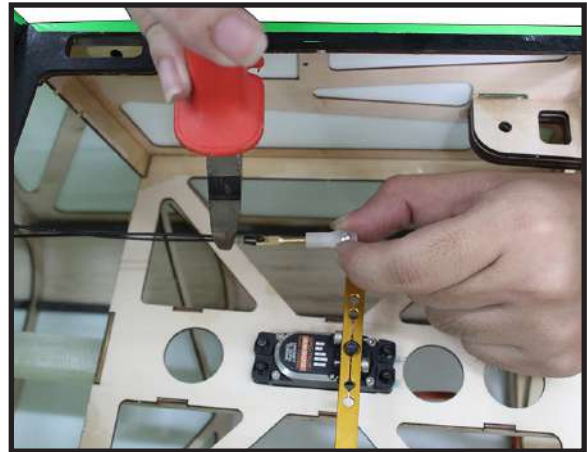

Cut off excess cable as shown.

16.

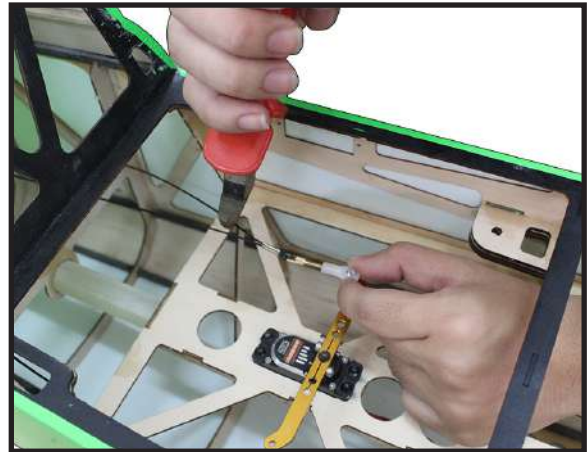

Attach ball links to the rudder servo arm and then attach the servo arm to the rudder servo as shown.



NOTE : Cable is installed crossed "X", not parallel.

Attach the aluminum tube to combine two elevator as below pictures.

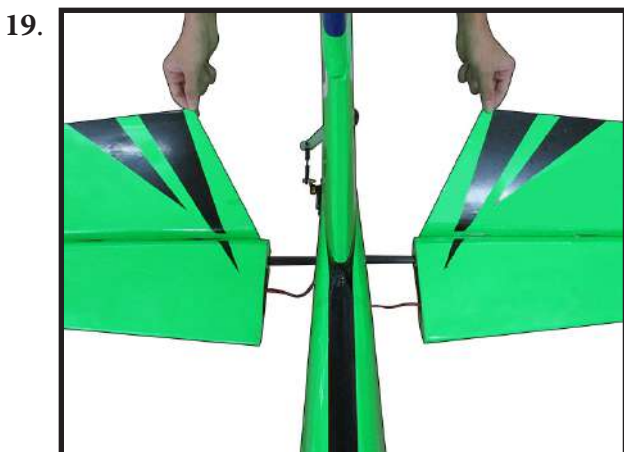

TAILWHEEL INSTALLATION

Locate items necessary to install tailwheel.

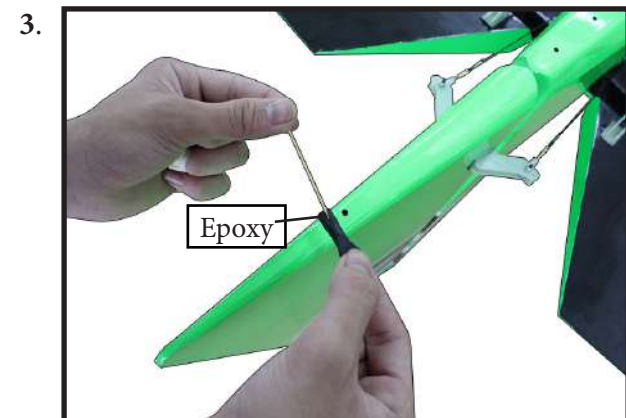
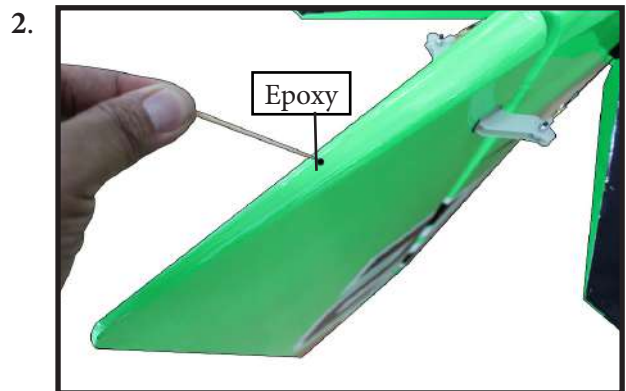

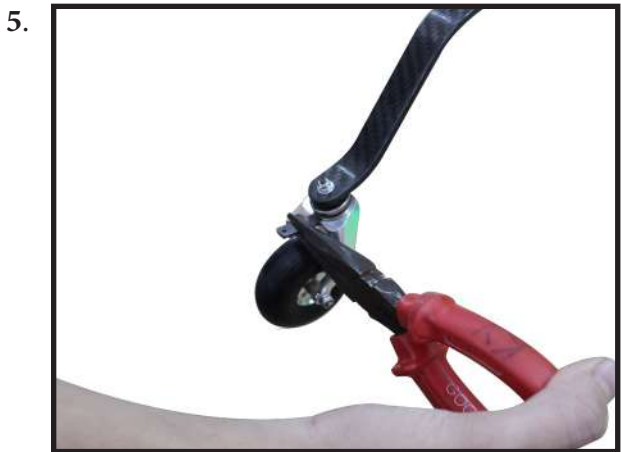



INSTALLING THE MAIN LANDING GEAR TO FUSELAGE

Please study images below.

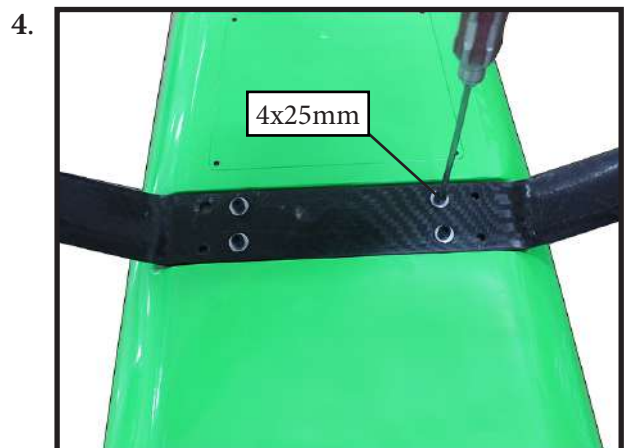

Install gear cover into landing gear.

The blind nuts for securing the landing gear are already mounted inside the fuselage.

Using the hardware provided, mount the main landing gear to the fuselage.

Place the fuselage inverted on the workbench in a suitable stand. Set the landing gear in place and use a screwdriver to secure the landing gear to the fuselage using bolts M4x25mm and washers. Make sure to use the threadlock on the bolts so they don't vibrate loose.

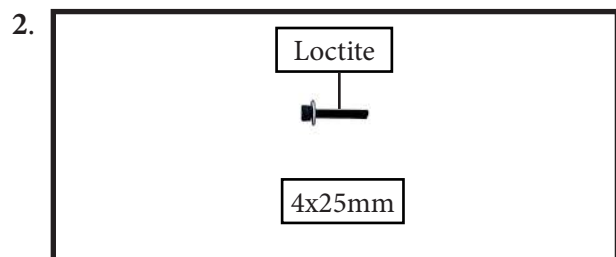
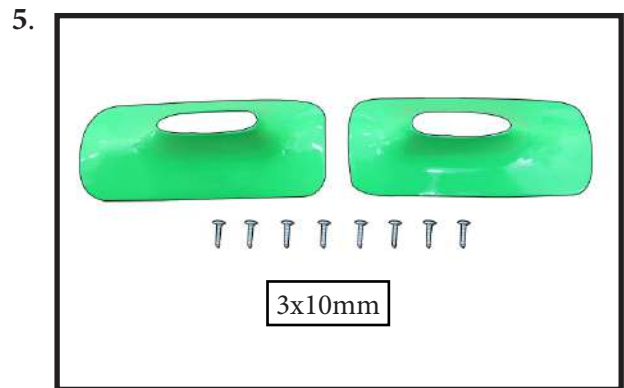

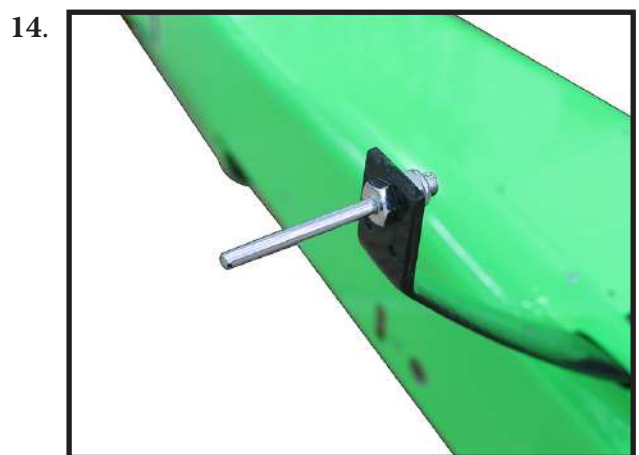
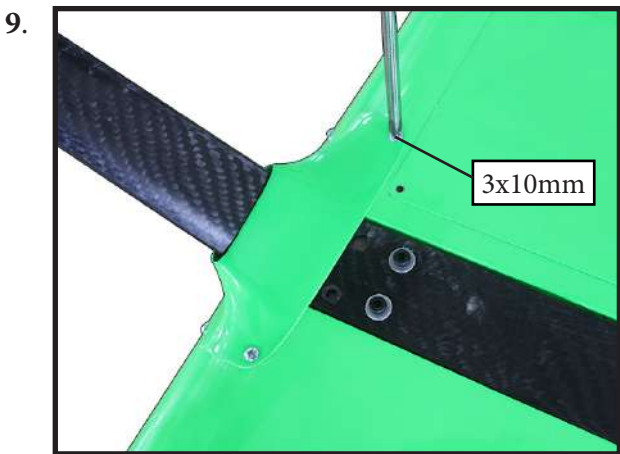
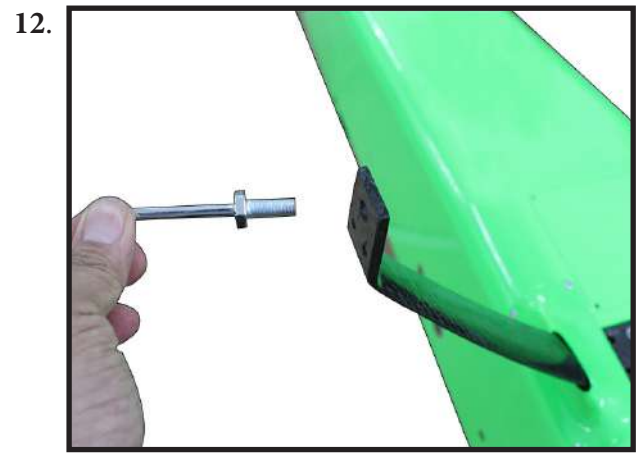
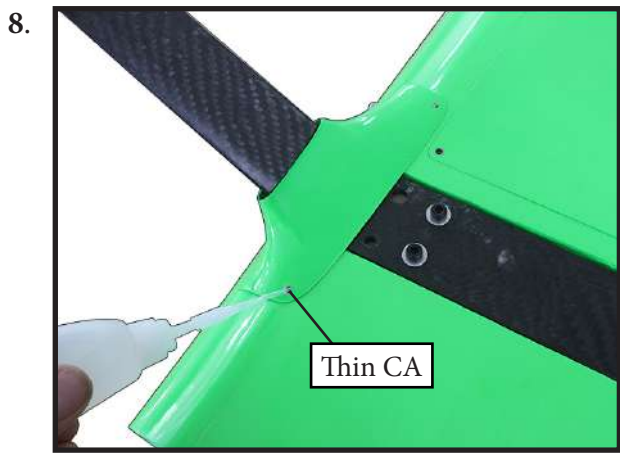
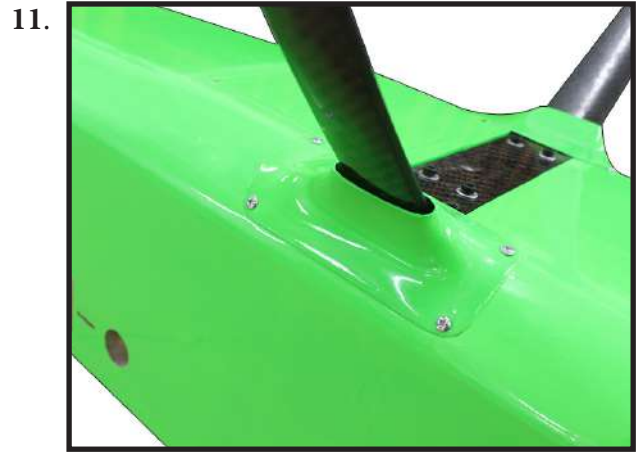
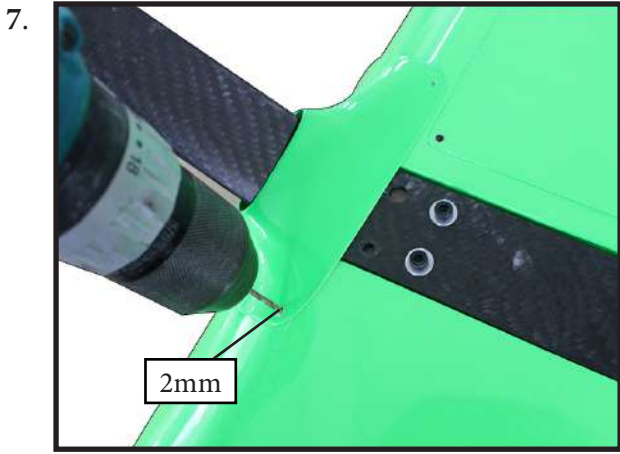

Align the wheel pant slot over the axle bolt as shown. Slide the wheel pant slot over the flat sides of the axle bolt and align blind nuts in wheel pants with mounting holes in landing gear. When all bolt holes are aligned tighten axle in place.

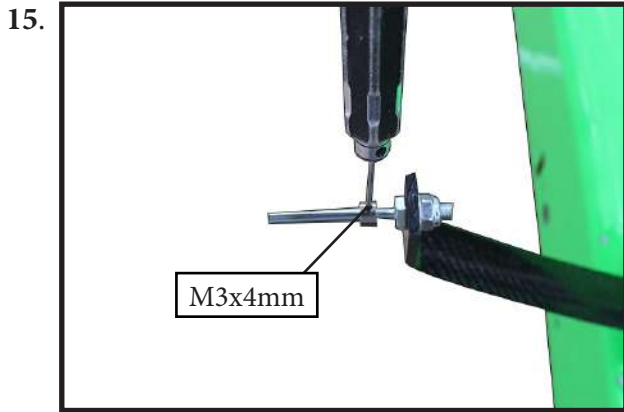

Install the wheel and outer wheel collar. Use blue Loctite on the wheel collar set screw before final tightening.

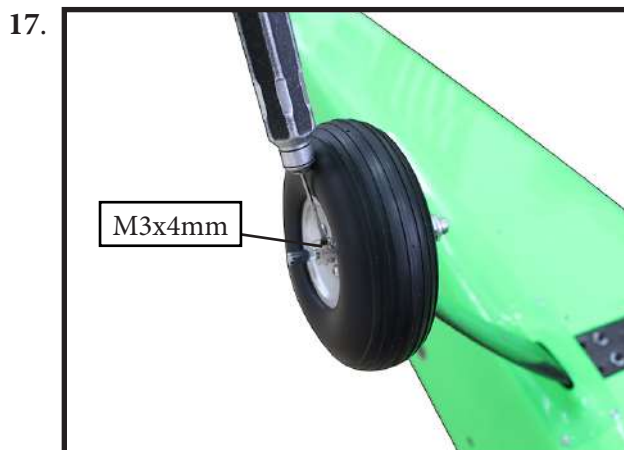

Use blue Loctite on the bolts before final tightening.

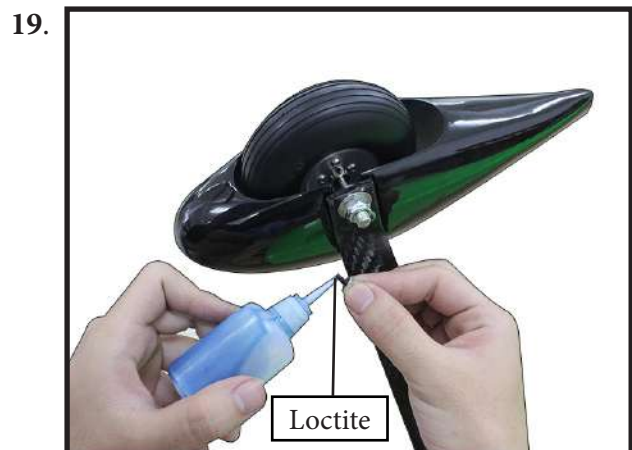
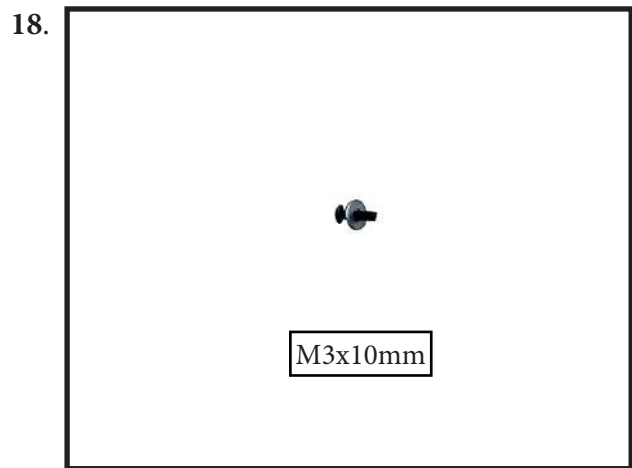

MOUNTING THE ENGINE

Use a 6.1mm bit to drill the engine mounting holes.

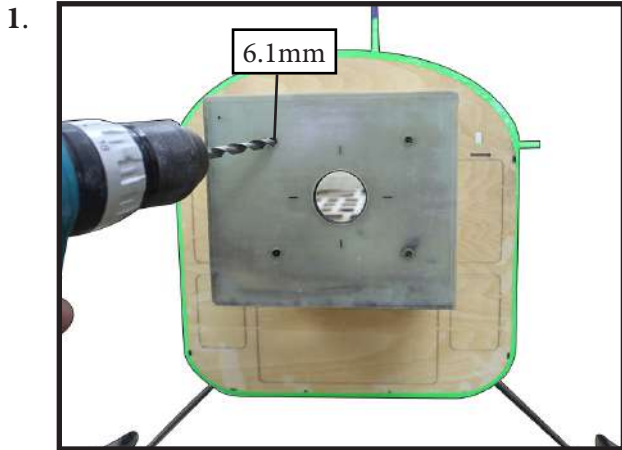

Remove mounting template from firewall. Firewall shown with mounting holes drilled ready for engine mounting.

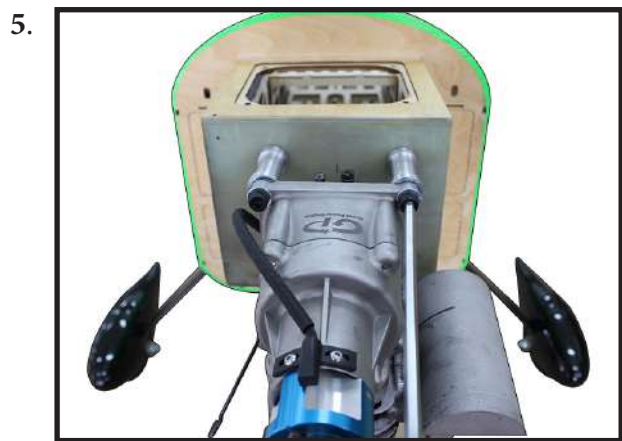
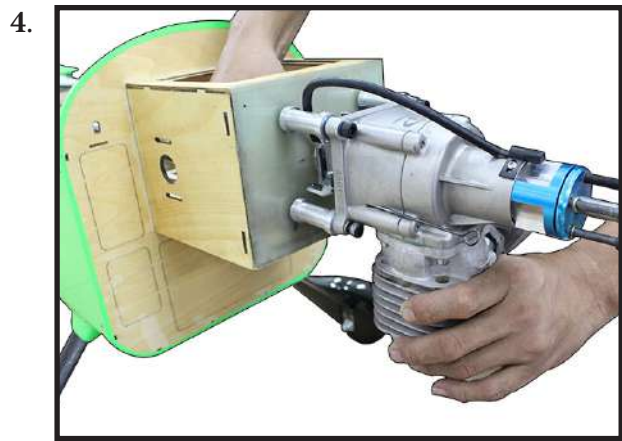
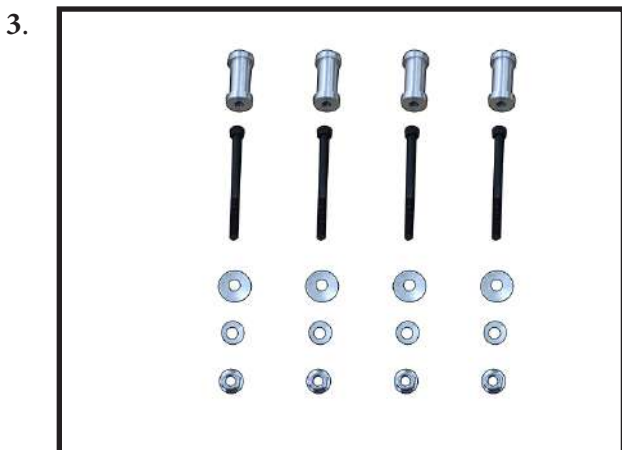
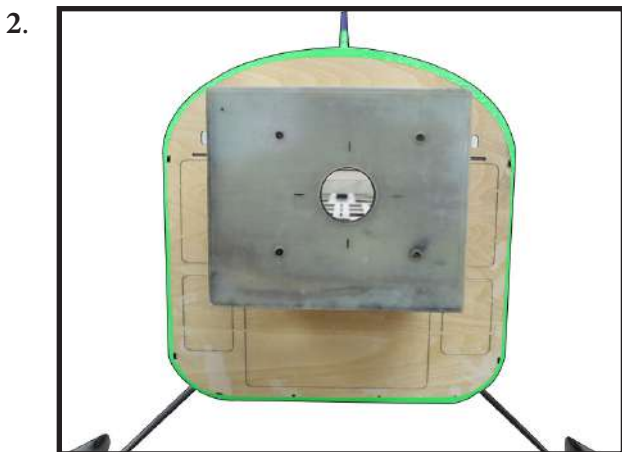

Tighten mounting bolts and secure engine to firewall.



THROTTLE SERVO INSTALLATION

1.



Use a 1/4" bit to drill a pushrod exit hole in the firewall in line with the engine carburetor throttle arm.

Assemble ball link to threaded end of pushrod.

2.

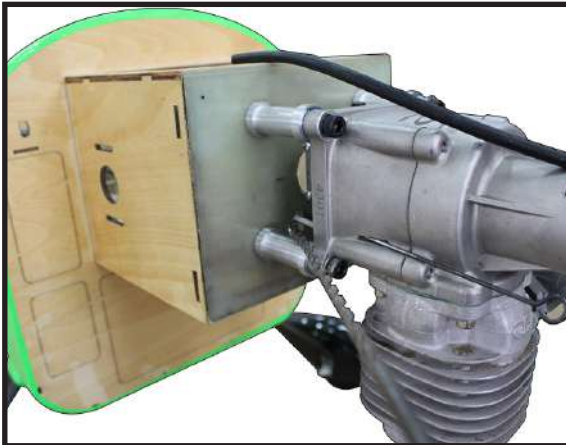

Attach throttle pushrod to the carburetor throttle arm with the ball link.

3.

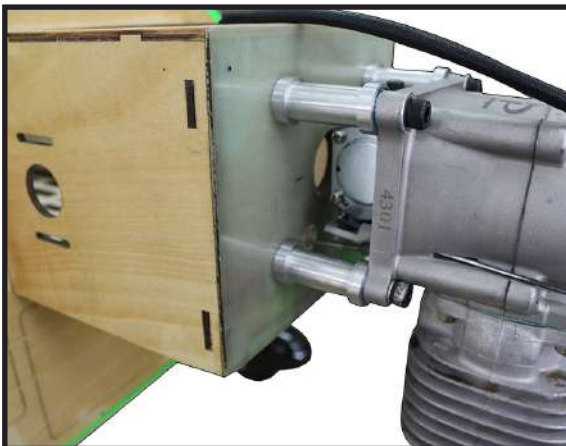

Install adjustable servo connector in the servo arm as same as picture below:

4.

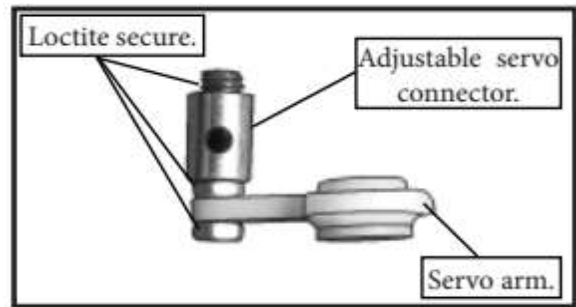

Install throttle servo into servo mounting tray

5.



Reinstall the servo horn by sliding the connector over the pushrod wire. Center the throttle stick and trim and install the servo horn perpendicular to the servo center line.

6.



Move the throttle stick to the closed position and move the carburetor to closed. Use a 2.5mm hex wrench to tighten the screw that secures the throttle pushrod wire. Make sure to use threadlock on the screw so it does not vibrate loose.



IGNITION INSTALLATION

Thread nylon tie through mounting holes.

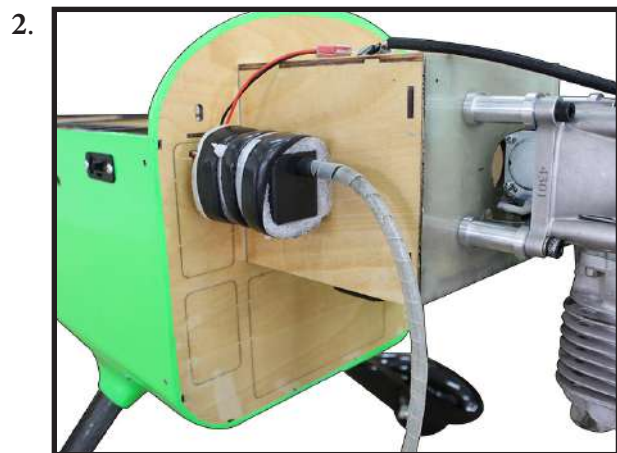

Connect ignition module to pickup line of engine. Secure with Safety Clip, safety wire, tape or other method. Ensure the plugs will not come apart from vibration or light tension.

Secure ignition wire with nylon ties as necessary.

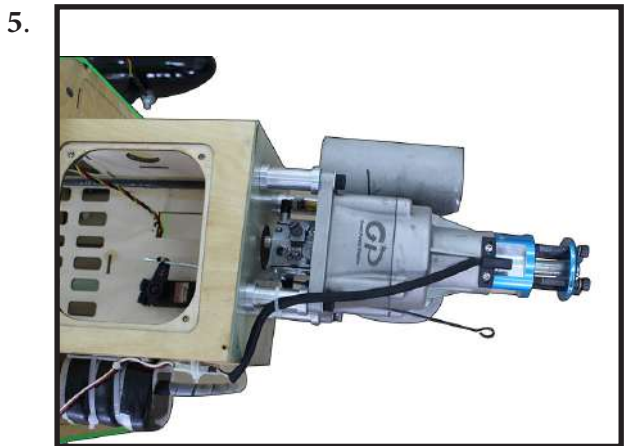
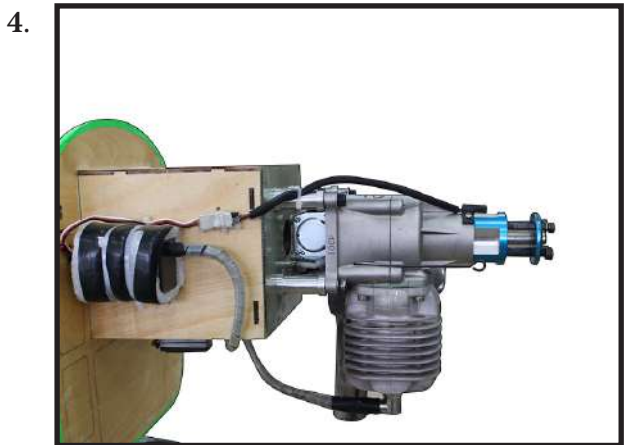
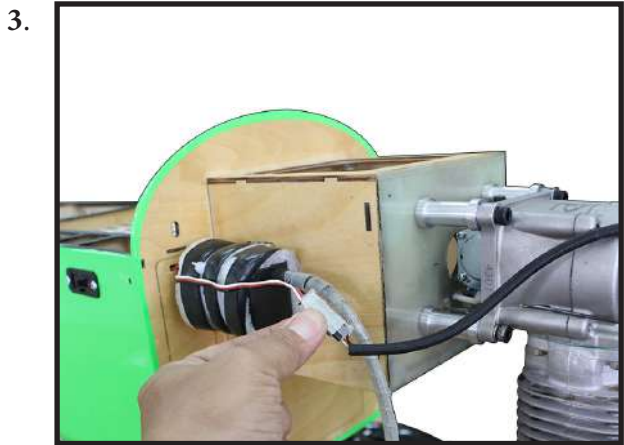

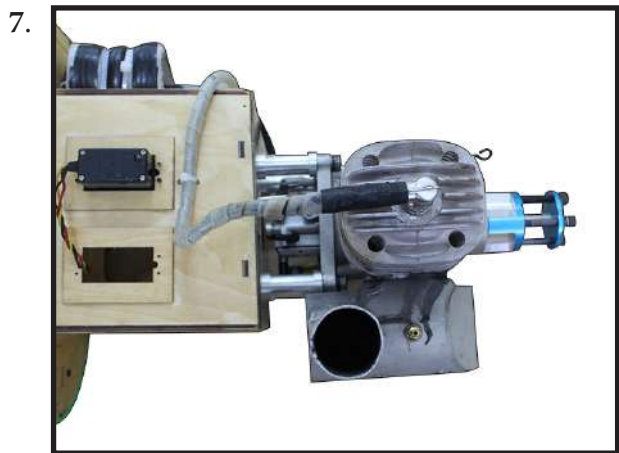

The lower part is the engine 76cc.

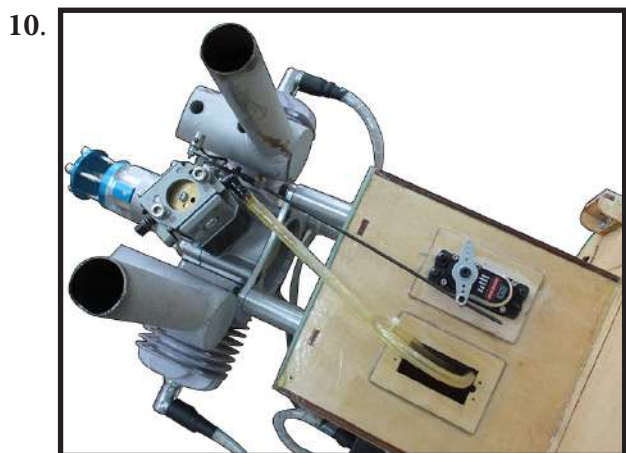
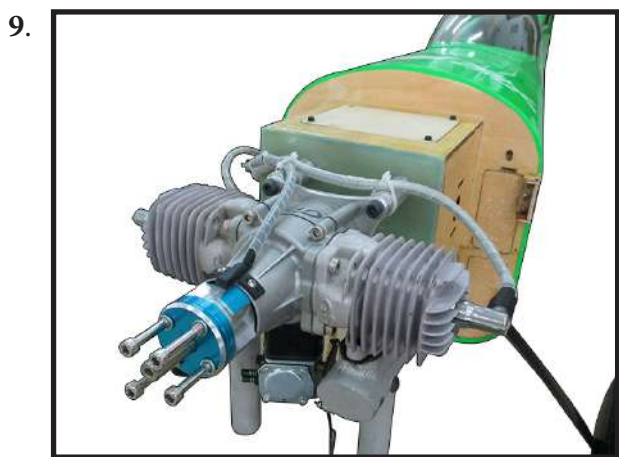
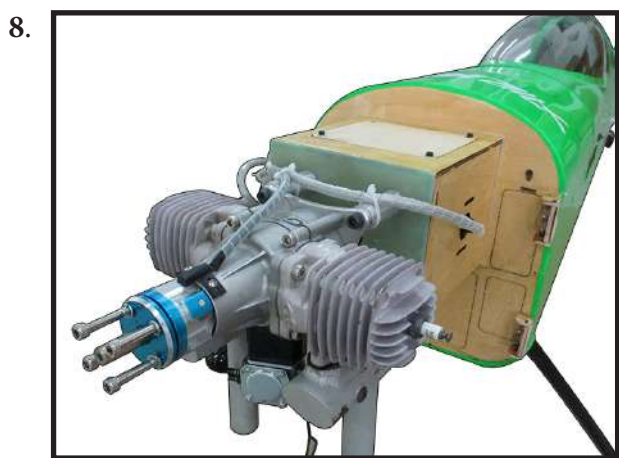

INSTALLING THE RECEIVER SWITCH

Install the switch into the precut hole in the side, in the fuselage.

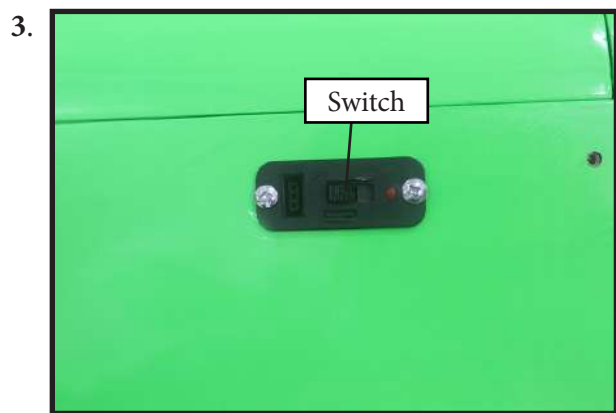
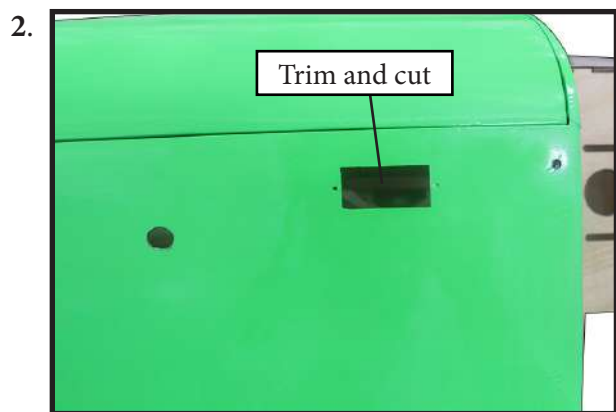
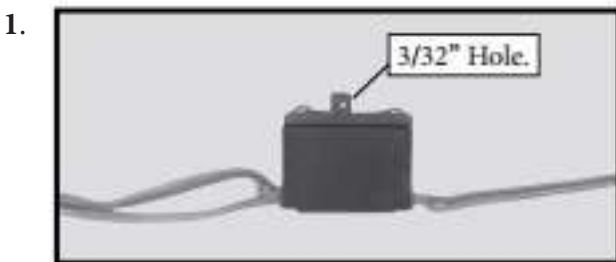

FUEL TANK ASSEMBLY

Please study images below.



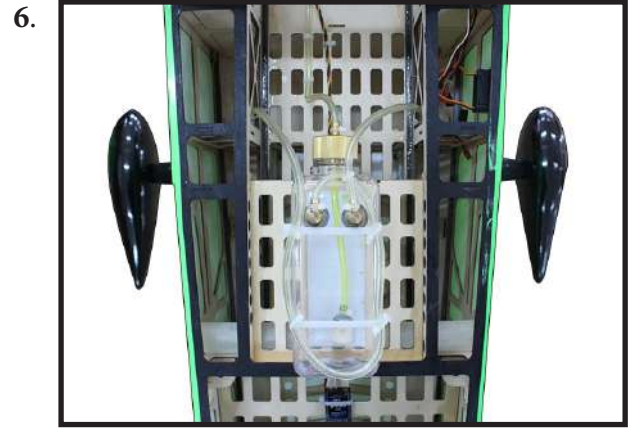
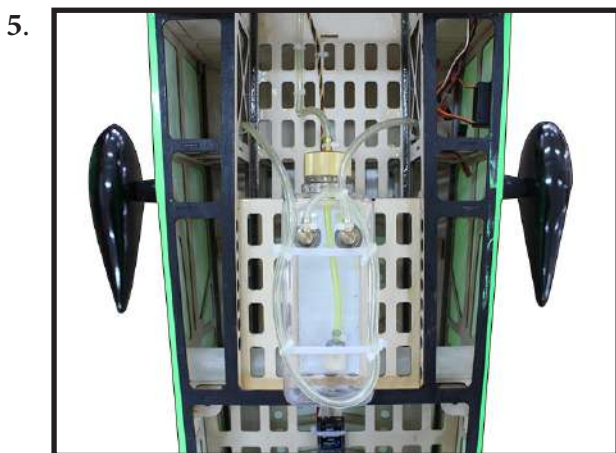
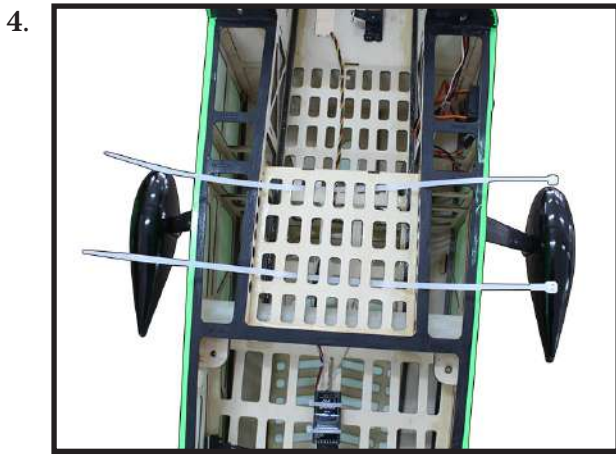
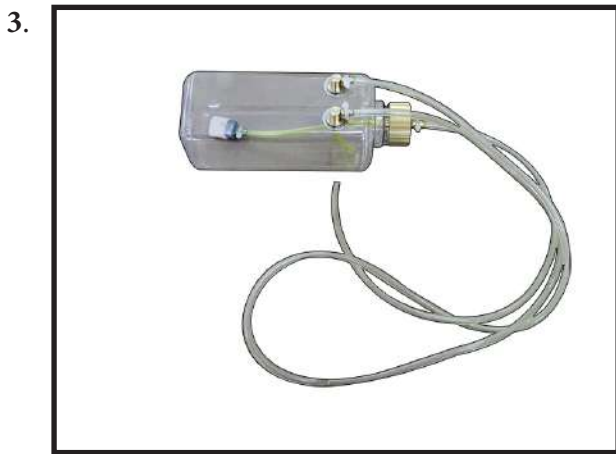

COWLING

Measure and mark the center of the bottom of the fuselage as shown. Mount cowl to fuse and transfer center line on fuse to bottom of cowl.

Note: You will use this center mark during a later step when aligning template with cowl.

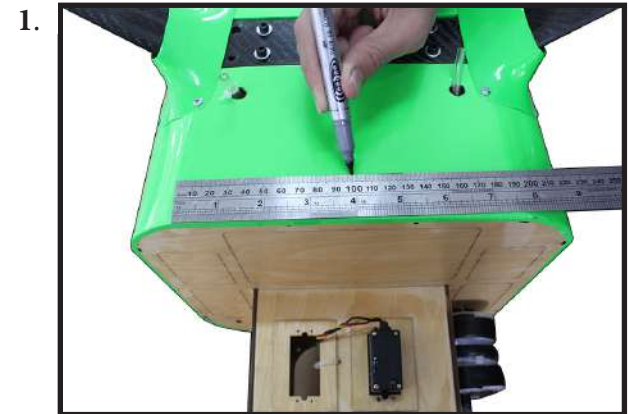

Aligning center lines of template and fuse. Tape the template to the bottom of the fuse with the back edge of the template flush against the aft edge of the recessed cowl mounting ring.

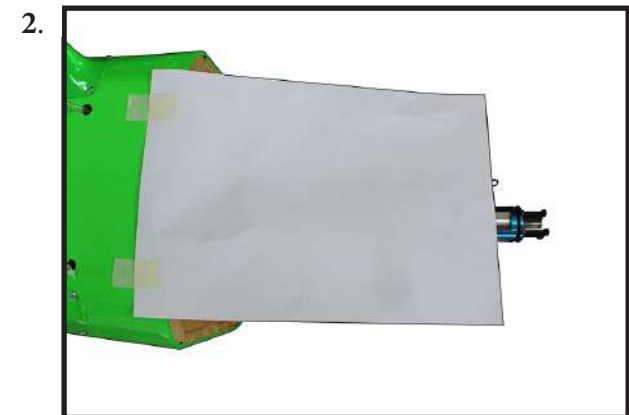

Fit template flush with rear of cowl and align center marks of template and cowl. Tape template to the bottom of cowl. Use a felt tip marker to transfer the template cutout pattern to the cowl and mark cut location.

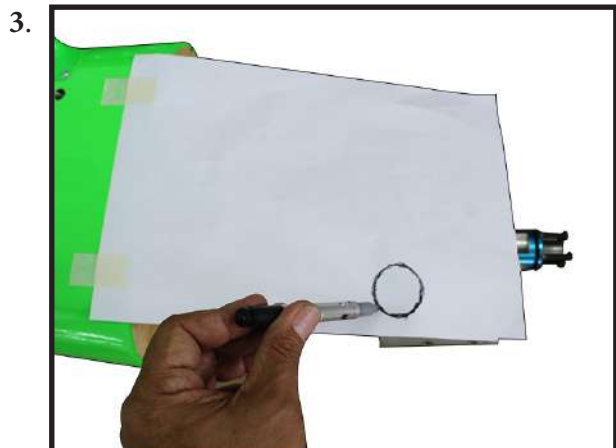

Using a hobby knife roughly cut a hole for the muffler exhaust stacks to pass through.

Note: This will allow you to pull the template up next the engine cylinder head.

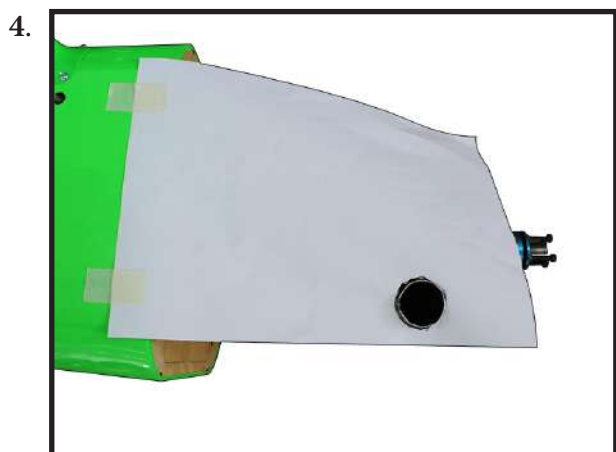

Fit template flush with rear of cowl and align center marks of template and cowl. Tape template to the bottom of cowl. Use a felt tip marker to transfer the template cutout pattern to the cowl and mark cut location.



The cowl should be marked as shown. Be sure to mark all of the lines clearly and carefully to aid in cutting.

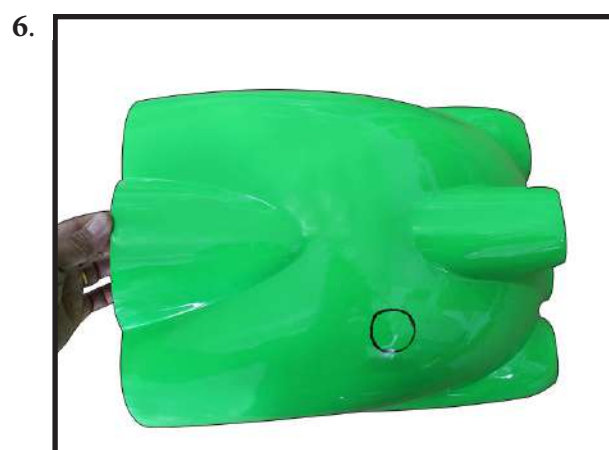

Remove the template and use a rotary cutting tool and sanding drum to cut out the openings in the cowl.

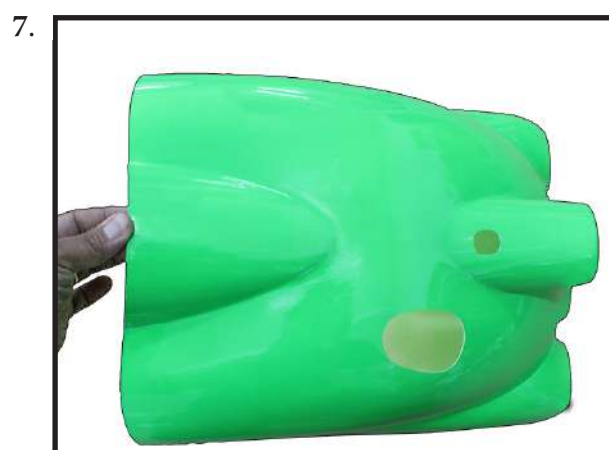

8.



Install the cowl and check that everything fits correctly and does not come in contact with the cowl. If needed enlarge the cutouts and test fit again until everything fits correctly.

Mark and tape the cowl to the fuselage using low-tack tape.

9.



10.



Mark by using a drill to drill the holes for the cowl mounting screws. Then, take cowl out of and drill on it. Make sure the cowl position is correct before drilling each hole.

11.



12.

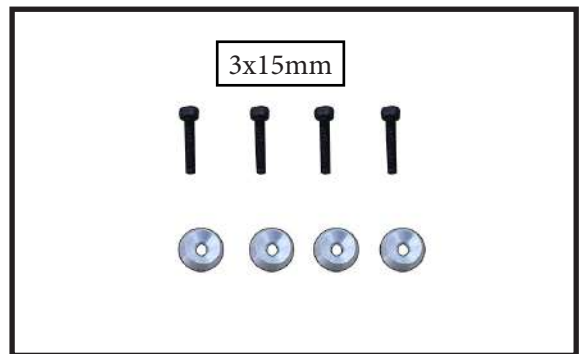

13.

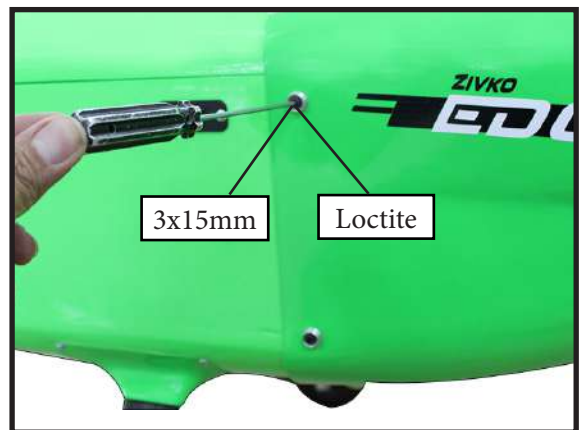

14.







ATTACHMENT WING - FUSELAGE

Attach the aluminium tube into fuselage.

INSTALLING THE SPINNER

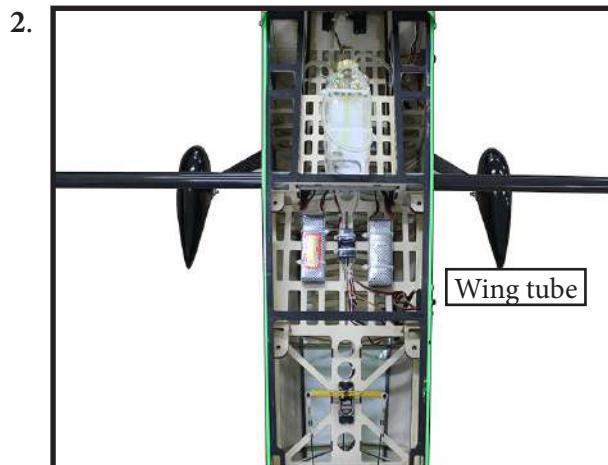
Install the spinner backplate, propeller and spinner cone.



 The propeller should not touch any part of the spinner cone. If it does, use a sharp modeling knife and carefully trim away the spinner cone where the propeller comes in contact with it.

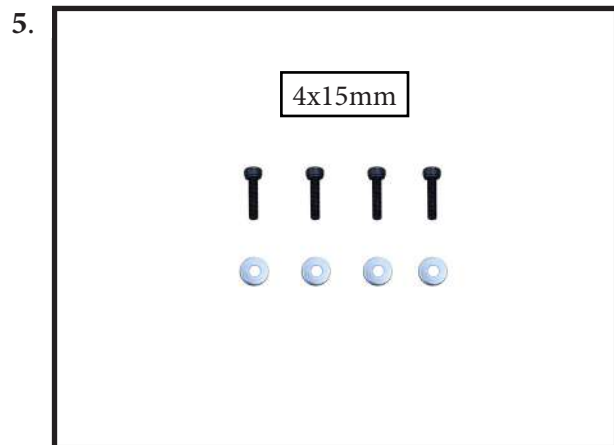
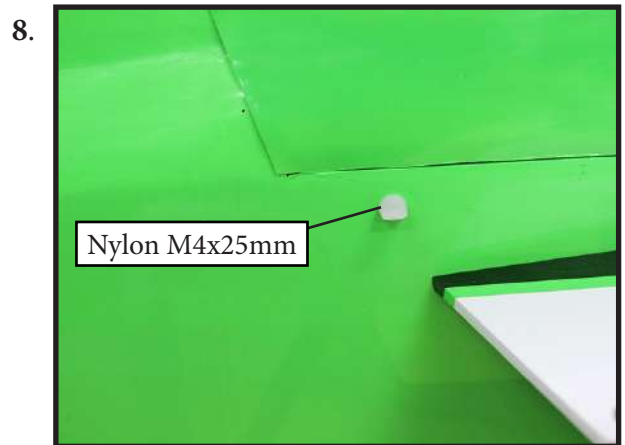
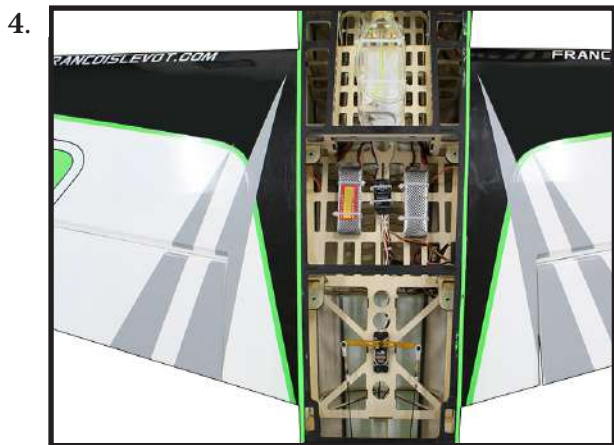
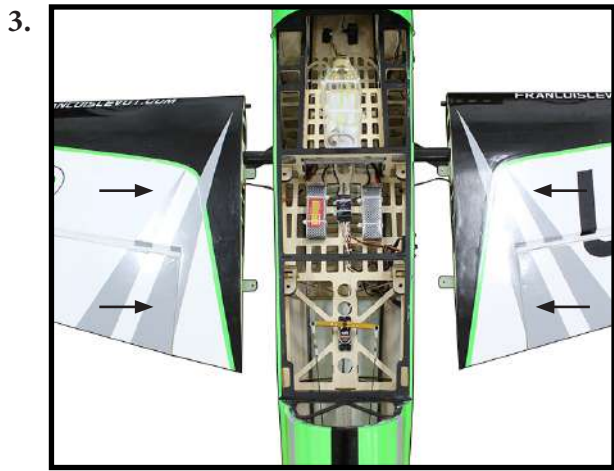

INSTALL WING TIP

Please study images below.

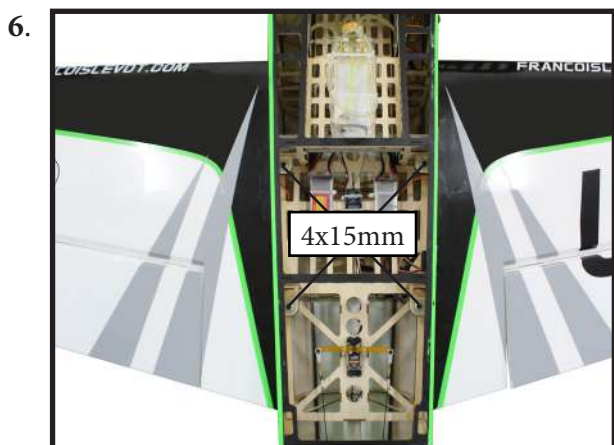

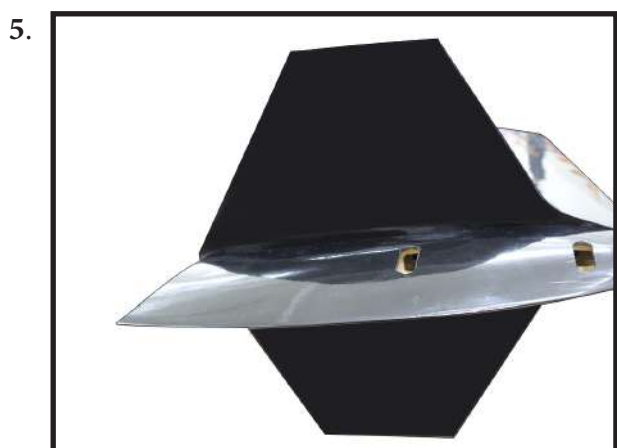
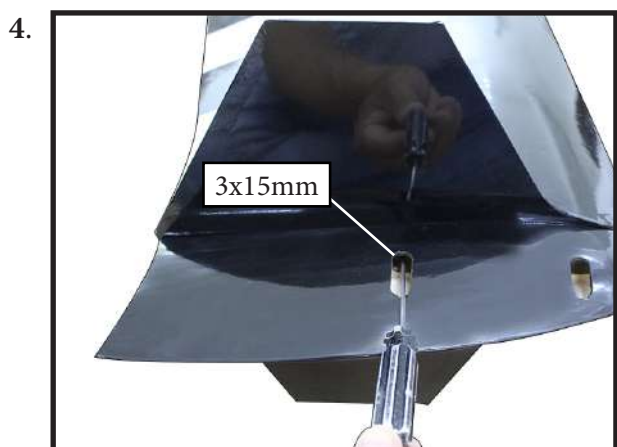
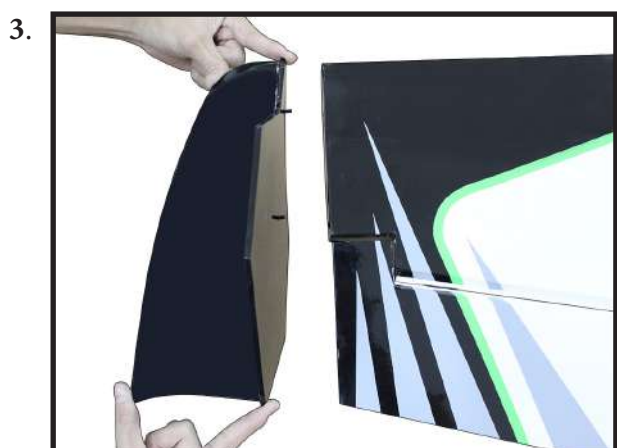
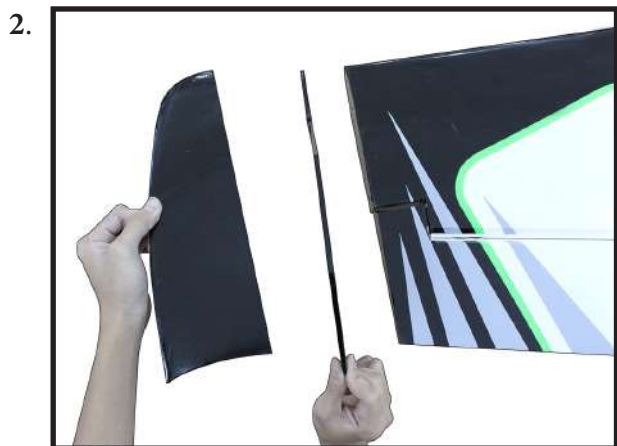

APPLY THE DECALS

If all the decals are precut and ready to stick. Please be certain the model is clean and free from oily fingerprints and dust. Position decal on the model where desired, using the photos on the box and aid in their location.

If all the decals are not precut, please use scissors or a sharp hobby knife to cut the decals from the sheet. Please be certain the model is clean and free from oily fingerprints and dust. Position decal on the model where desired, using the photos on the box and aid in their location.

BALANCING

An important part of preparing the aircraft for flight is properly balancing the model.

1) Attach the wing panels to the fuselage. Make sure to connect the leads from the aileron to the appropriate leads from the receiver. Make sure the leads are not exposed outside the fuselage before tightening the wing bolts. Your model should be flight-ready before balancing.

2) The recommended Center of Gravity (CG) location for your model is (165mm) back from the leading edge at the center of the wing.

3) When balancing your model, make sure it is assembled and ready for flight. Support the plane upright at the marks made on the wing with your fingers or a commercially available balancing stand. This is the correct balance point for your model.

*If possible, first attempt to balance the model by changing the position of the receiver battery and receiver. If you are unable to obtain good balance by doing so, then it will be necessary to add weight to the nose or tail to achieve the proper balance point.

With the wings attached to the fuselage, all parts of the model installed (ready to fly), and empty fuel tanks, hold the model at the marked balance point with the stabilizer level.

Lift the model. If the tail drops when you lift, the model is “tail heavy” and you must add weight* to the nose. If the nose drops, it is “nose heavy” and you must add weight* to the tail to balance.

1.

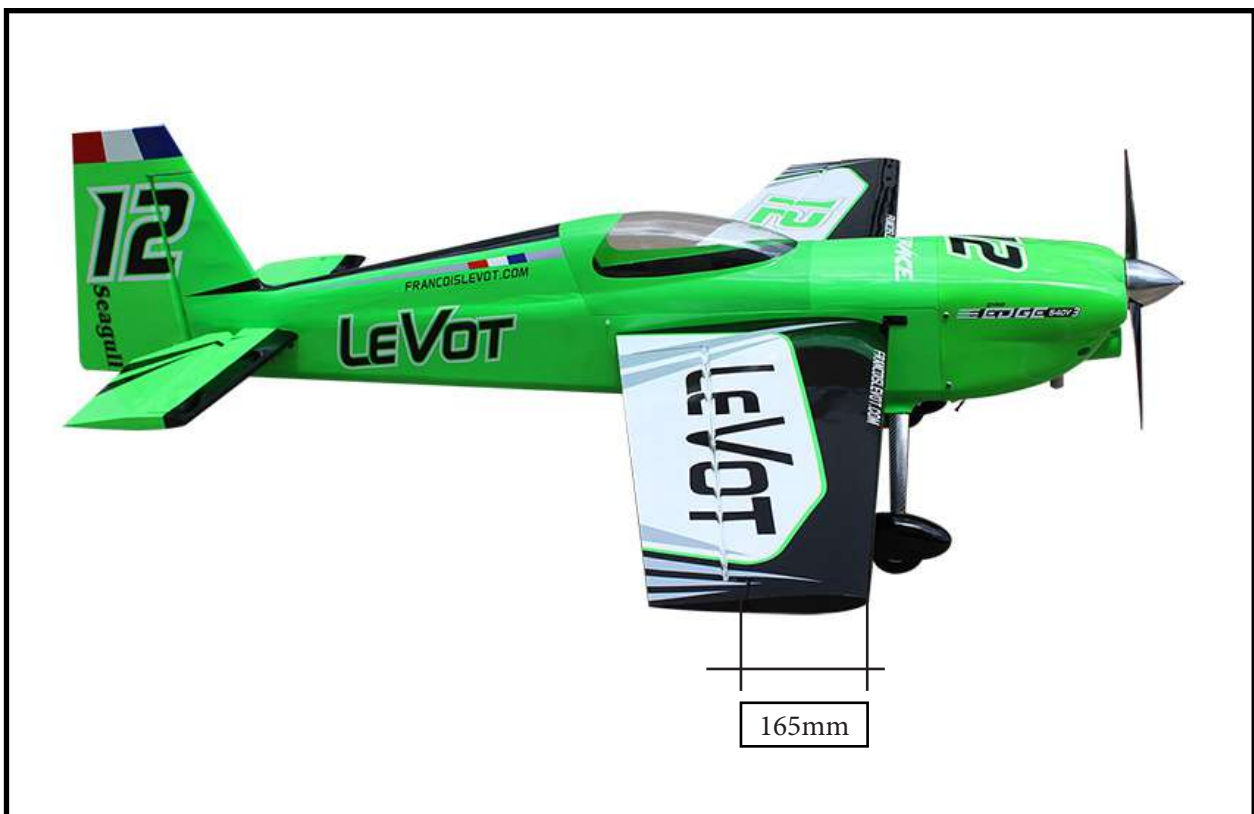

CONTROL THROWS

Surface throw control

I recommend buying a throw meter that is in degrees. There are several units available on the market. or you can install the support software available on the market today to your smartphone to do it clearly. These units are a great help in setting and definitely beat the “look at” correct “. For any type of precision flight, equal distance travel surfaces are a must. The the following control surface moves are what I use on my own edge. This is a good starting point, but by no means the only way to set up Edge. Start here and then adjust to your own taste and flying style.

Elevator: 10-12 degrees low rate, 18-20% exponential
all you can get for high rate, 50-60% exponential.

Aileron: 18-20 degrees low rate, 30-40% exponential
all you can get for high rate, 50-60% exponential.

Rudder: 20 degrees low rate, 50% exponential
all you can get for high rate, 60-70% exponential.

FLIGHT PREPARATION

Check the operation and direction of the elevator, rudder, ailerons and throttle.

A) Plug in your radio system per the manufacturer's instructions and turn everything on.

B) Check the elevator first. Pull back on the elevator stick. The elevator halves should move up. If they do not, flip the servo reversing switch on your transmitter to change the direction.

C) Check the rudder. Looking from behind the airplane, move the rudder stick to the right. The rudder should move to the right. If it does not, flip the servo reversing switch on your transmitter to change the direction.

D) Check the throttle. Moving the throttle stick forward should open the carburetor barrel. If it does not, flip the servo reversing switch on your transmitter to change the direction.

E) From behind the airplane, look at the aileron on the right wing half. Move the aileron stick to the right. The right aileron should move up and the other aileron should move down. If it does not, flip the servo reversing switch on your transmitter to change the direction.

PREFLIGHT CHECK

1) Completely charge your transmitter and receiver batteries before your first day of flying.

2) Check every bolt and every glue joint in the **Zivko Edge 540 V3 - 92" wingspan 60-70cc** to ensure that everything is tight and well bonded.

3) Double check the balance of the airplane. Do this with the fuel tank empty.

4) Check the control surfaces. All should move in the correct direction and not bind in any way.

5) If your radio transmitter is equipped with dual rate switches double check that they are on the low rate setting for your first few flights.

6) Check to ensure the control surfaces are moving the proper amount for both low and high rate settings.

7) Check the receiver antenna. It should be fully extended and not coiled up inside the fuselage.

8) Properly balance the propeller. An out of balance propeller will cause excessive vibration which could lead to engine and/or airframe failure.

*We wish you many safe and enjoyable flights
with your Zivko Edge 540 V3 - 92" wingspan 60-70cc.*

*If you have any queries, or are interested in our products,
please feel free to contact us*

Factory : 12/101A - Hamlet 4 - Le Van Khuong Street - Dong Thanh Ward -
Hoc Mon District - Ho Chi Minh City - Viet Nam.

Office : 62/8 Ngo Tat To Street - Ward 19 - Binh Thanh District - Ho Chi Minh
City - Viet Nam

Phone : 848 - 86622289 or 848- 36018777

Website : www.SeagullModels.com

Email : Sales@seagullmodels.com

Facebook : www.facebook.com/SeaGullModels.