

# WFLY

Shenzhen WFLY Technology Development Co., Ltd

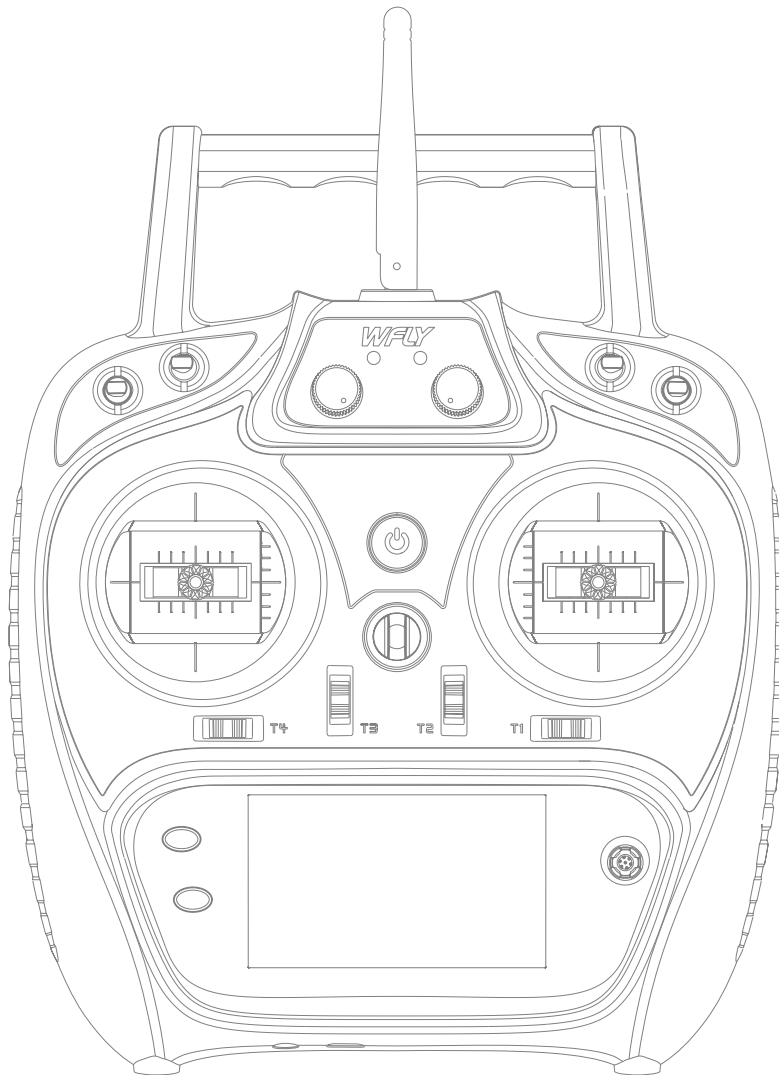

WFLY Wechat

(ET Series)8-channel Digital Proportional R/C System

## ET08 INSTRUCTION MANUAL

Thank you for using WFLY products!

- Please read this product manual carefully before using this product!
  - Please use this product correctly!
- The model is not a toy, for safety, please don't fly at crowded places!

——Shenzhen WFLY Technology Development Co., Ltd



## **Safety Precautions**

- 06 Symbols Definition
- 06 Flying Precautions
- 07 Battery
- 08 Trainer Port
- 08 USB Port

## **Before Use**

- 09 Product Features
- 09 Basic Configuration
- 10 Each Parts Name Of Transmitter
- 11 Switch Configuration and Model Types
- 11 The Travel of Antenna Direction Adjustment

## **Basic Operation**

- 12 Home Interface Introduction
- 13 Indicator Light of Transmitter
- 13 Stick Adjustment
- 14 Left and Right Hand Mode Replacement Method
- 15 Receiver Instructions
  - Receiver and servo connection example:
- 16 -Airplane
- 17 -Helicopter
- 18 -Multicopter

## **Basic Setting Sequence of Models**

- 19 -Airplane
- 20-21 -Helicopter



## **System Setting**

- 22 Model Select
- 23 Model Type
- 24 Trainer
- 25 Display
- 26 User Name
- 27 Low Battery
- 28 Sound
- 29 Language
- 30 Stick Mode
- 31 Calibration
- 32 Data Reset
- 33 Information
- 34 Screen Lock Set

## **Linkage Setting**

- 35 Link
- 36 Telemetry
- 37 PPM/W.BUS
- 38 Receiver Output
- 39 Fail Safe
- 40 Relay Flight
- 41 Servo Frequency
- 42 BUS Servo Setting
- 43 180/270° Servo
- 44 Range Check

## **General Menu**

- 45 Monitor
- 46 Function
- 47 Servo Reverse
- 48 Dual Rate
- 49 End Point
- 50 Timer
- 51 Trim Setting
- 52 Sub-Trim
- 53 Channel Delay
- 54 Program Mixes
- 55 Flight Mode
- 56 Double Engine



### **Model Menu\Helicopter**

- 57 Condition
- 58 Throttle Curve
- 59 Pitch Curve
- 60 Throttle Hold
- 61 Throttle Cut
- 62 Gyro
- 63 Governor
- 64 Swash

### **Model Menu\Airplane**

- 65 Condition
- 66 AIL Differential
- 67 Throttle Curve
- 68 Throttle Hold
- 69 Throttle Cut
- 70 Gyro
- 71 Airbrake
- 72 ELE to Camber
- 73 Winglet
- 74 Elevator
- 75 V-Tail
- 76 Flywin

### **Model Menu\Multicopter**

- 77 Condition
- 78 Throttle Curve
- 79 Throttle Hold
- 80 Throttle Cut
- 81 Stick Alarm
- 82 Gyro



# Safety Precautions

## Symbols Definition

Pay special attention to the safety information of the following symbols!

### DANGER

If without a proper operation, it may cause dangerous accident or seriously injury or may even cause death.

### WARNING

If without a proper operation, it may cause dangerous accident or seriously injury or may even cause death, and it may cause slight hurt or probability cause bodily injure!

### NOTICE

If without a proper operation, it may cause less possibility to serious hurt, but it may cause hurt or bodily injure.



Prohibitions



Mandatory

## Flying Precautions

### Disclaimer & Warning

User should be responsible for any consequences caused by using the product. WFLY shall not be liable for any directly or indirectly damage, injury and any legal liability, User shall comply with all guidelines including but not limited to this document.

Please follow the local laws and regulations for regular flight activities. Do not use this product to carry out personal safety, property safety or other bad flight behaviors.

### WARNING

**To ensure the safety of yourself and others, please observe the following precautions:**

Charge the batteries! Check transmitter and receiver battery level and always recharge the batteries before each flying session. A low battery will soon die potentially, causing loss of control and a crash. When you begin your flying session, reset your ET08 built-in timer, and during the session, reset your ET08 built-in timer, and during the session pay attention to the duration of usage.

Be careful when flying near electric wires, high-rise buildings or communication facilities, as there may be radio interference around.

### DANGER



Mandatory

Beginners should pay particular attention to the following safety precautions! Please read carefully!

No fly when user is in poor health condition such as fatigue and drunkenness.

No fly in bad weather day such as rain, strong wind or at night, etc.

No fly near high voltage wires, communication base stations, government secret zone or public places where crowds gathered.

No fly in airports and other places where fly is forbidden.

Before flying, inspect the aircraft carefully, inspect whether the aircraft and transceiver system it's normal. When flying, make the transmitter display to the initial interface, in case of mistaken parameter change. After flight, turn off the receiver power before turn off the transmitter power, in case of any injury caused by fail safe works.

More debugging, more testing, less loss, less damage!

### NOTICE



Mandatory

Power on and off sequency of transmitter and receiver!

### Power on:

Firstly turn on the transmitter (ensuring the minimum throttle position), Secondly Turn on the receiver.

### Power off:

Firstly turn off the receiver, Secondly turn off the transmitter.

Transmitter and receiver low voltage may cause fail-safe danger!

**Note: The transmitter will display the warning interface, please pay attention to the transmitter prompt! Improperly operation may cause accident injury to user.**



## Battery

Lithium polymer battery (Short for LiFe battery), please use the WFLY special charger only. It is important to understand the operating characteristics of Li-Fe batteries.

### DANGER

Long term storage (more than 3 months), storage temperature  $\leq 45^{\circ}\text{C}$  general storage voltage 3.7-3.9v. Failure to follow the proceeding precautions can quickly result in severe, permanent damage to the batteries and possibly result in a fire!

### NOTICE

1. Do not attempt to disassemble LiFe packs or cells.
2. Do not allow LiFe cells to come in contact with moisture or water at any time.
3. Always provide adequate ventilation around LiFe batteries during charge, discharge, while in use, and during storage.
4. Do not leave a LiFe battery unattended at any time while being charged or discharged.
5. Do not attempt to charge LiFe batteries with a charger that is NOT designed for LiFe batteries, as permanent damage to the battery and charger could result.
6. Always charge LiFe batteries in a fireproof location. Do not charge or discharge LiFe batteries on carpet, a cluttered workbench, near paper, plastic, vinyl, leather or wood, or inside an R/C model or full-sized automobile! Monitor the charge area with a smoke or fire alarm.
7. Do not charge LiFe batteries at currents greater than the "1C" rating of the battery ("C" equals the rated capacity of the battery).
8. Do not allow LiFe cells to overheat at any time! Cells which reach greater than 140 degrees Fahrenheit ( $60^{\circ}\text{C}$ ) should be placed in a fireproof location.
9. LiFe cells will not charge fully when too cold or show full charge.
10. It is normal for the batteries to become warm during charging, but if the charger or battery becomes excessively hot disconnect the battery from the charger immediately!! Always inspect a battery which has previously overheated for potential damage, and do not re-use if you suspect it has been damaged in any way.
11. Do not use a LiFe battery if you suspect physical damage has occurred to the pack. Carefully inspect the battery for even the smallest of dents, cracks, splits, punctures or damage to the wiring and connectors. DO NOT allow the battery's internal electrolyte to get into eyes or on skin—wash affected areas immediately if they come in contact with the electrolyte. If in doubt, place the battery in a fire-proof location for at least 30 minutes.
12. Do not store batteries near an open flame or heater
13. Do not discharge LiFe batteries at currents which exceed the discharge current rating of the battery.
14. Always store LiFe cells/packs in a secure location away from children.

### NOTICE

#### Transmitter (ET08):

ET08 adopts the power supply mode of lithium battery, and the working voltage adapts to the range of 3.7-6V. Using a power supply that exceeds the operating voltage stroke may burn the machine!

The USB interface of ET08 can be used to charge the common mobile phone charger (5V)!

#### Receiver (RF206S):

The receiver's operating voltage adapts to the range 3.8V-6.5V, with anti-reverse protection slot (power input pole, positive and negative reverse protection). With a power supply that exceeds the operating voltage stroke, the receiver will burn out!



## Trainer Port

### ! Mandatory

#### Transmitter trainer port:

The trainer port is with 3.5mm audio port output mode. This suite is without the trainer data line. If you want to use the trainer function, you need to purchase the trainer data line separately!

Warning: This port is only used for trainer data transmission. It is forbidden to insert the power supply (high voltage) terminal to the port to avoid damage for the transmitter.

Trainer/Simulator port

USB port

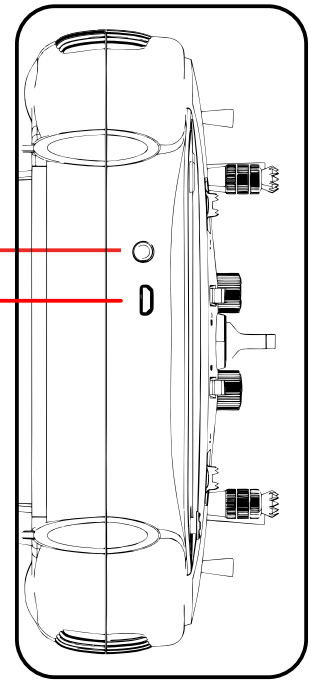

## USB Port

### ! Mandatory

#### Transmitter USB port:

ET08 adopt standard USB port for upgrading function!

Warning: This port is only used as upgrading data transmission, it is forbidden to insert the power supply (high voltage) terminal to the USB port to avoid damage for the transmitter



# Before Use

## Product Features

### Transmitter

Model: ET08  
Channel: 8 channels  
Voltage: 3.7V-6V (1S lithium battery)  
Current: 150mA  
Applications: helicopters/airplanes/multicopters/robots/cars/ boats  
Resolution: full channel 4096  
Band: 2.4GHz(bidirectional)  
HFSS:64points,3.6ms  
Storage: 16 groups  
Program: 5 program mix  
Language: Chinese, English  
Upgrade: USB upgrade  
Display: 3.5 inches, 128x64 dot matrix screen  
Relay flight: support  
180/270° servo: support  
Wireless copy: model data

### Receiver

Type: RF206S  
Band: 2.4GHz  
Voltage: 3.8V-6.5V  
Current: 80mA  
Applications: helicopters/airplanes/multicopters/robots/cars/ boats  
Frequency: FHSS 4096  
PWM: 6 channels  
PPM: support  
W.BUS: compatible S.BUS  
Two-way transmission: support  
Fail-safe: support  
180/270° servo: support  
Receiver port setting: support  
External voltage detection: DC 0~36V  
Dimension: 36x20x12mm

## Basic Configuration

ET08 transmitter x1  
RF206S receiver x1(include external power detection line x1)  
Summary manual x1

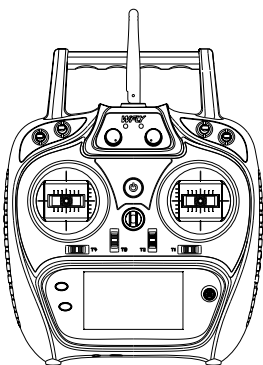

Transmitter

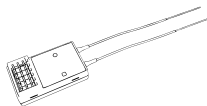

Receiver

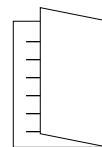

Summary Manual

# Before Use

## Each Parts Name Of Transmitter

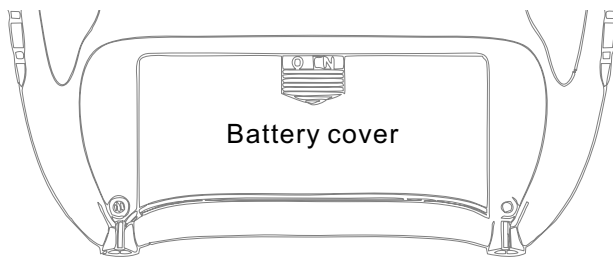
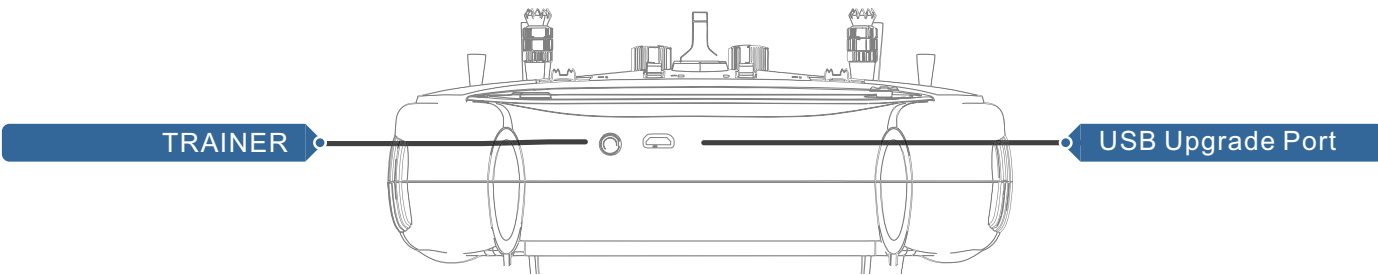
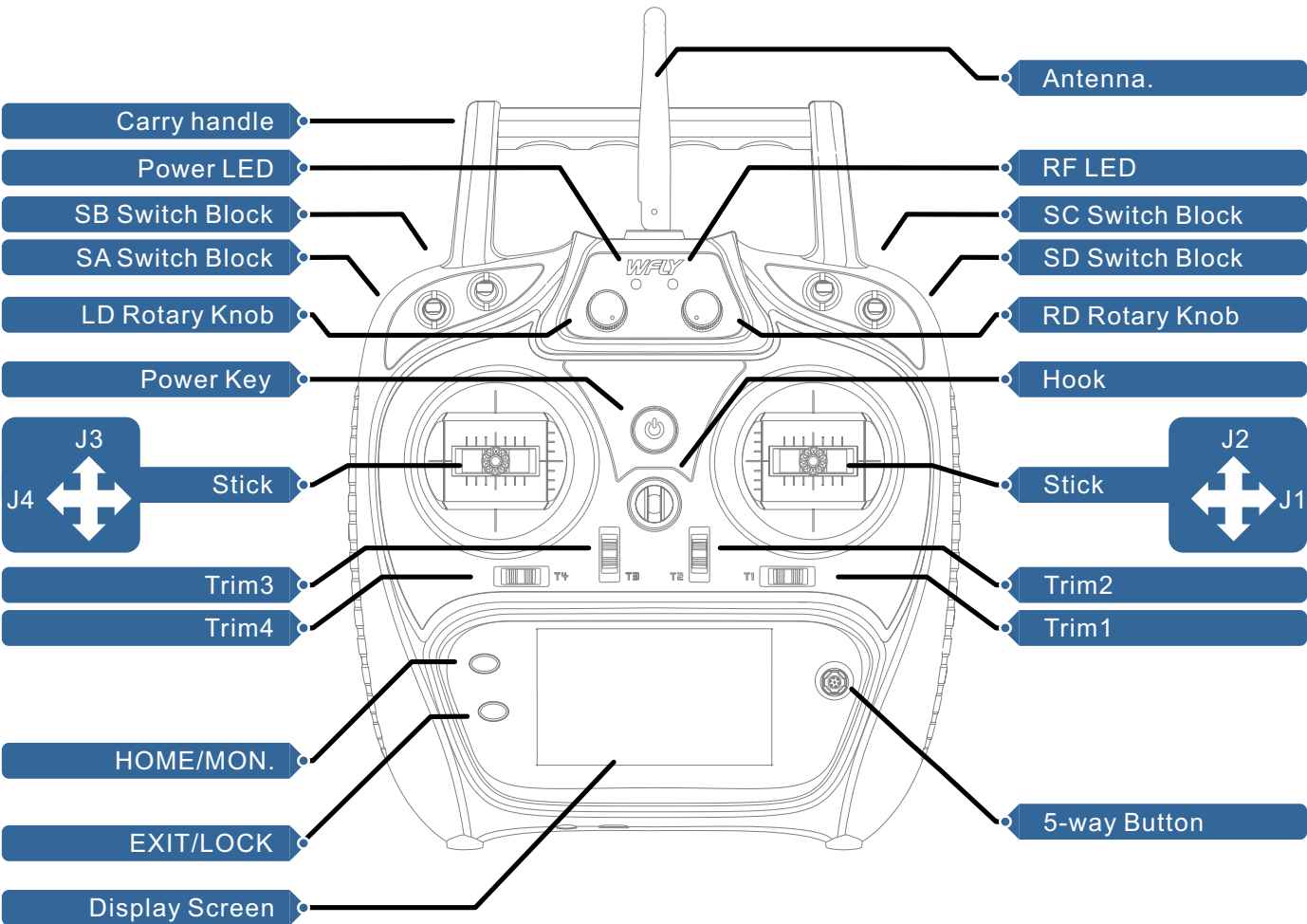

## Switch configuration and model types

Power LED: Left, power indicator light, red  
RF LED: Right, RF indicator light, blue.

POWER: Click and hold for 3 seconds to open/shut down;

SA: Short lever 2 positions (user-defined)  
SB: Long lever 3 positions (user-defined)  
SC: Long lever 3 positions (user-defined)  
SD: Short lever 2 positions (user-defined)  
LD/RD: Rotary Knob(User-defined)  
T1-T4:Trim,(User-defined)

TRAINER: Trainer port

5-way button: Move the cursor button up and down or left and right, middle button for confirmation(Long press to reset).

HOME/MON.: Home/Monitor key, slightly click home, press and hold monitor.

EXIT/LOCK: Exit/Lock key, slightly click to exist, press and hold to lock the screen.

## The Travel Of Antenna Direction Adjustment

### ! Mandatory

Avoid metal objects covering the handle position when in use.

The following is the "antenna position indication image" and "signal strength and position relationship diagram":

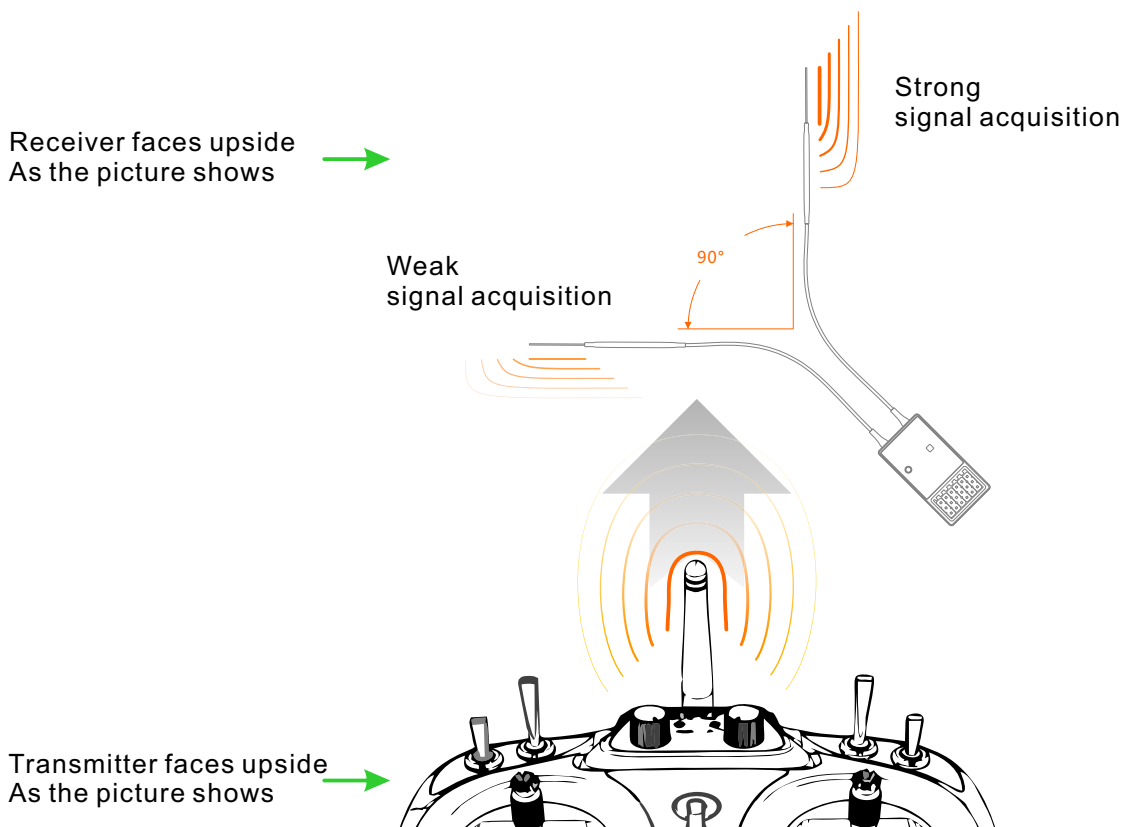

# Basic Operation

## Home Interface Introduction

Home Interface 1

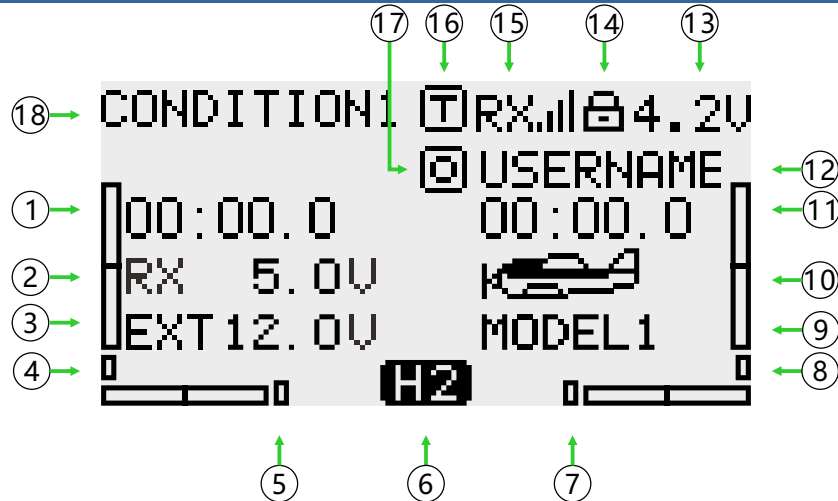

Home Interface 2

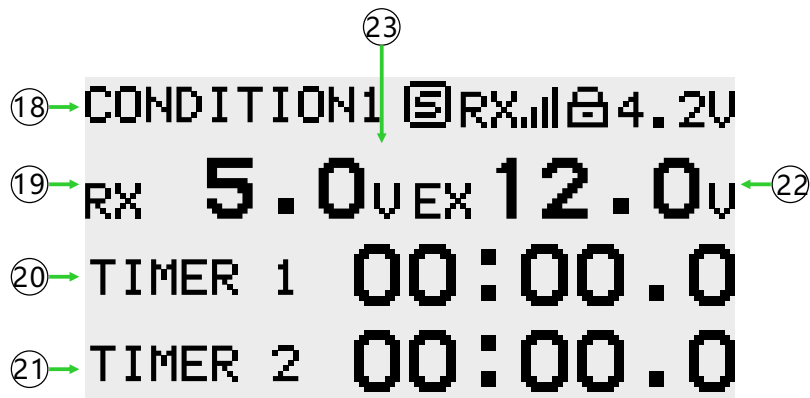



### Introduction and operation

- 1-20. Timer 1
2. Return data(Receiver voltage)
3. Return data(External battery)
- 4-5-7-8. Trim monitor, display active trimming status
6. "Home2" key, click to enter Home Interface 2
9. Model name: Click to enter model select interface
10. Model type: Click to enter current model type interface
- 11-21. Timer 2
12. User name, click into user defined name
13. Transmitter battery voltage
14. Lock(Click EXIT/LOCK 2s to enter lock status)
15. Receiver signal strength
16. Student (S), Trainer(T), 8channel simulator(8)mode status
17. Throttle hold ( T ) and throttle cut ( C )status
18. Fly mode, current fly mode
19. Return data(Receiver voltage)
22. Return data(External battery voltage)
23. "Home interface2", "Confirm Key" "Return Key" or "Home Key" switch back to "Home Interface 1"



## Indicator Light of Transmitter

Power LED  
Red  

RF LED  
Blue  

LED	Status
Power LED on	Power on
Power LED off	Power off
RF LED off	Power off , Student or Simulator mode
RF LED on	Normal Linkage, Trainer or Normal mode
RF LED flash	Enter link status

## Stick Adjustment

Stick head height adjustment:

1. Loosen the upper section head counterclockwise
2. Then twist the lower head to adjust the height
3. Twist the upper head clockwise to lock it



## Left and right stick mode replacement method

It is not recommended to replace the left and right sticks by yourself, otherwise the transmitter may be damaged.

Required tools: 3 mm cross screwdriver, 1.5 mm hex driver

Firstly open the transmitter housing and then follow the instructions shown below:

1 Loosen the bearing housing screws (the screws do not need to be fully retracted), then remove the spring, bracket 7 and bracket 5 and tighten the screws; then remove the removed spring, bracket 7 and bracket 5 in another assembly corresponding position (remove the bearing housing screw before assembly), The tightness of the stick can be changed by adjusting the height of screw 3.

2 Remove the screw of the throttle reed, the throttle reed and the throttle sleeve, and install them in the corresponding position of the other assembly. According to your own habits, select the type of throttle sliding (toothed and smooth) and adjust the screw (screw 1 or The height of the screw 2) makes the damping of the throttle conform to your own habits.

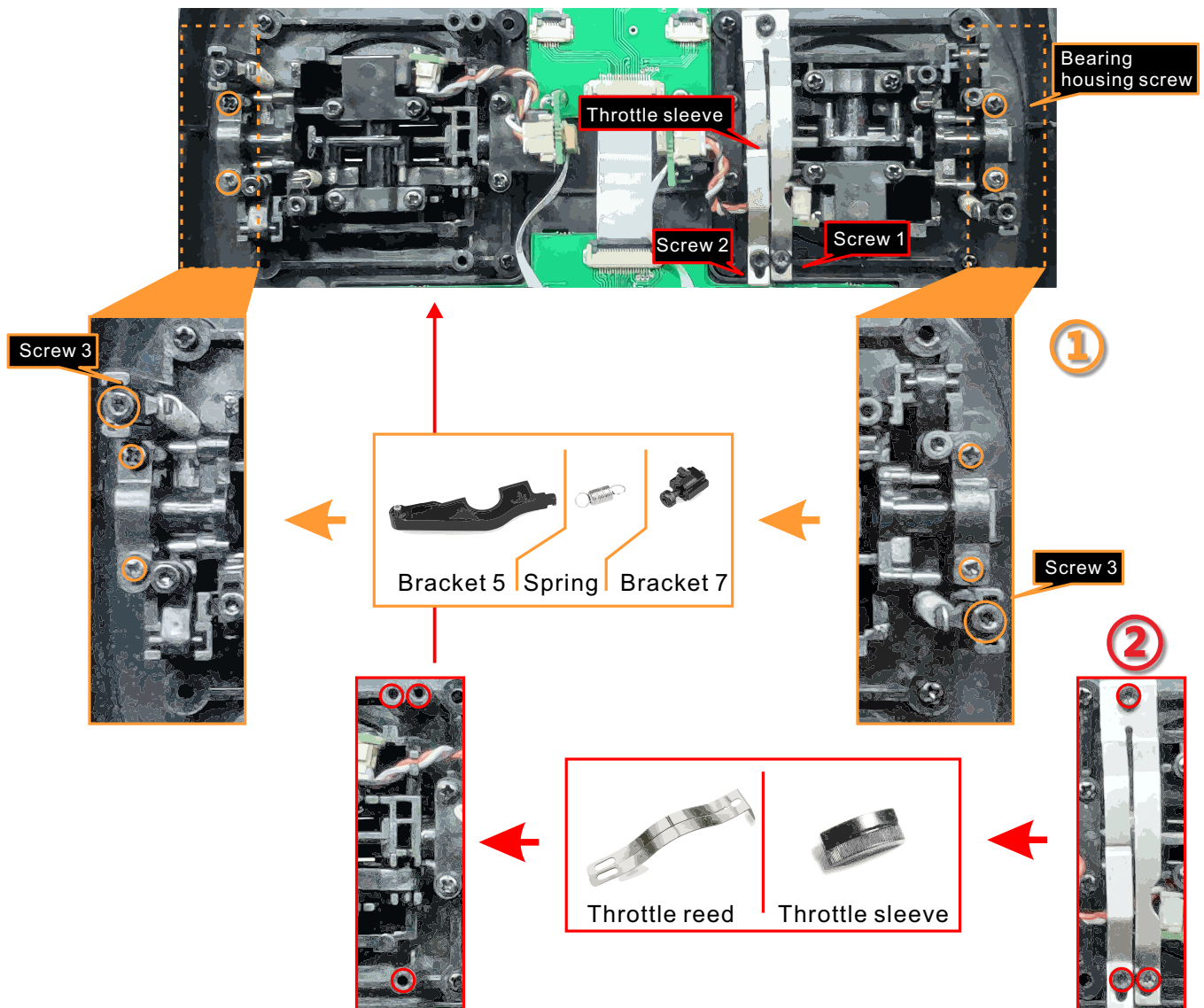

After the throttle structure is modified, turn on the machine, enter [system setting] → [stick mode], select the corresponding operation mode, and then adjust the stick after replacing the left and right modes! If you need components such as bracket 5 (such as the parts needed for assembling double circuit structure!), you can e-mail to WFLY overseas seller to order the spare parts at [sales@wflysz.com](mailto:sales@wflysz.com).



## Receiver Instructions

### Receiver LED STATUS LIST

Mode	LED	Action	Status
Work	Purple	Never	PWM normal work mode
	Green	Never	W.BUS normal work
	Blue	Never	PPM normal work mode
	Red	Never	No signal
	Red	Slowly flash	Low voltage
	Orange	Slowly flash	Linking

**Link:** Charge the receiver then press and hold 'SET' button for 3 seconds, wait for the link instruction after the orange light slowly flashes (LINKAGE SETTING) → (LINK).

**PPM/W.BUS/PWM port modes select:** Enter the interface [LINKAGE SETTING] - [RECEIVER OUTPUT], switch the working status of the last port of the receiver (default 6 channels), and return to the previous interface to save the settings.

### Receiver connection and installation

The working voltage of the receiver is 3.8-6.5V. Each port can be used as the power input terminal.

**Notice:** pay attention to the positive and negative polarity when connecting the power supply. Do not use the power supply that exceeds the working voltage of the receiver. Otherwise, the receiver will be damaged!

The RF206S is the newest series of high performance receiver with 6 PWM channels, the last channel port is PWM/PPM/W.BUS channel (User defined).

In order to obtain optimal signal retrieval performance, the two antennas are preferably processed 90° to each other when installed, as shown in the right diagram.

### ! Mandatory

1. If there is a metal conductor around the receiver antenna, the signal performance would be affected. In this case, the antenna should be bypassed by the conductor, placed on both sides of the fuselage, and it is better to make the antenna leak outside the model casing! In this way, good signal reception can be maintained regardless of the flight attitude.
2. When the antenna is installed. The unshielded end of the antenna should be as far away as possible from the conductor materials such as metal and carbon fiber. The antenna cable avoids bending at large angles. And the end core should be as straight as possible.
3. If the model body is covered with a conductive material such as carbon fiber or metal, the antenna portion must be extended beyond the body. At the same time, do not stick too close to the conductive body after the antenna is extended. In addition, the antenna should also be kept away from the fuel tank.

The receiver has an external battery detection interface, which can be used to view voltage information such as ESC, battery, etc., and the transmitter can separately set alarm voltages for the receiver voltage and external voltage. Pay attention to the positive and negative polarity when using the detection wire!

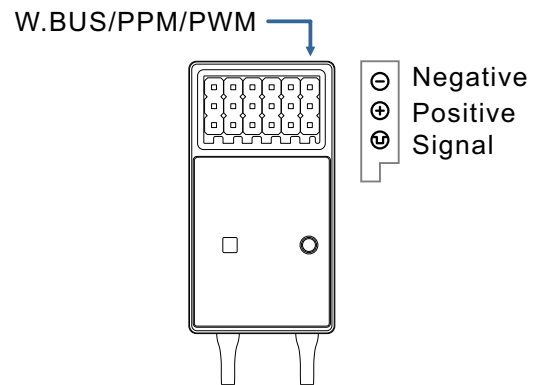

External voltage detection port polarity signs



The resistance is connected to the negative pole

The red is connected to the positive pole

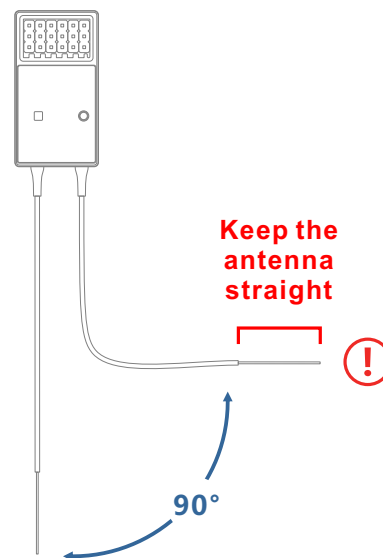

# Basic Operation

## Receiver and servo connection example - Airplane

The figure below shows an example of airplane connection. Please use the actual wing type and tail type for servo connection.

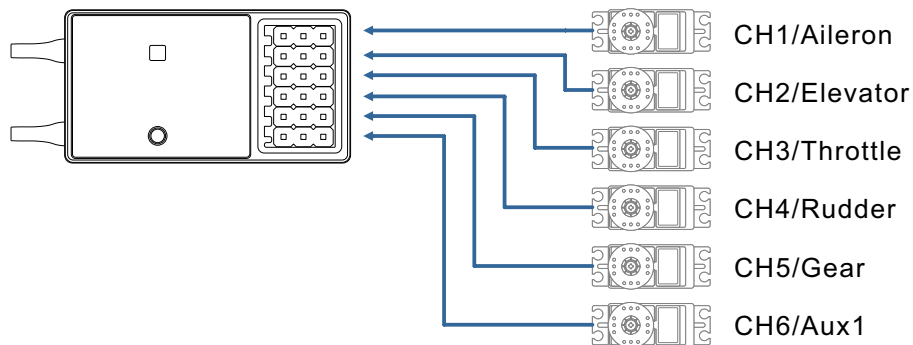

### Servo connection position (Airplane, refer to stick mode "Mode 1")

The table below shows examples of the servo connection positions for the different wing types and tail types(system default settings)

Type	Wing	Delta wing	Tail		CH1	CH2	CH3	CH4	CH5	CH6	CH7	CH8
Airplane	1 AIL		Normal	Channel	AIL	ELE	THR	RUD	Gear	AUX1	AUX2	AUX3
				Control	J1	J3	J2	J4	SD	--	--	--
				Trim	T1	T3	T2	T4	--	--	--	--
	1 AIL		V-Tail	Channel	AIL	ELE	THR	RUD	Gear	AUX1	AUX2	AUX3
				Control	J1	J3	J2	J4	SD	--	--	--
				Trim	T1	T3	T2	T4	--	--	--	--
	1 AIL		Ailevator	Channel	AIL	ELE	THR	RUD	Gear	升降2	AUX2	AUX3
				Control	J1	J3	J2	J4	SD	--	--	--
				Trim	T1	T3	T2	T4	--	--	--	--
	2 AIL		Normal	Channel	AIL	ELE	THR	RUD	Gear	AIL2	AUX2	AUX3
				Control	J1	J3	J2	J4	SD	--	--	--
				Trim	T1	T3	T2	T4	--	--	--	--
	2 AIL		V-Tail	Channel	AIL	ELE	THR	RUD	Gear	AIL2	AUX2	AUX3
				Control	J1	J3	J2	J4	SD	--	--	--
				Trim	T1	T3	T2	T4	--	--	--	--
	2 AIL		Ailevator	Channel	AIL	ELE	THR	RUD	ELE2	AIL2	AUX2	AUX3
				Control	J1	J3	J2	J4		--	--	--
				Trim	T1	T3	T2	T4	--	--	--	--
		2AIL	Normal	Channel	AIL	AIL2	THR	RUD	Gear	ELE	AUX2	AUX3
				Control	J1	--	J2	J4	SD	J3	--	--
				Trim	T1	--	T2	T4	--	T3	--	--
	2AIL	Winglet	Channel	AIL	AIL2	THR	RUD	RUD2	ELE	AUX2	AUX3	
			Control	J1	--	J2	J4	--	J3	--	--	
			Trim	T1	--	T2	T4	--	T3	--	--	



# Basic Operation

## Receiver and servo connection example - Helicopter

The figure below shows an example of helicopter connection. Please use the swash type that is actually used for the servo connection.

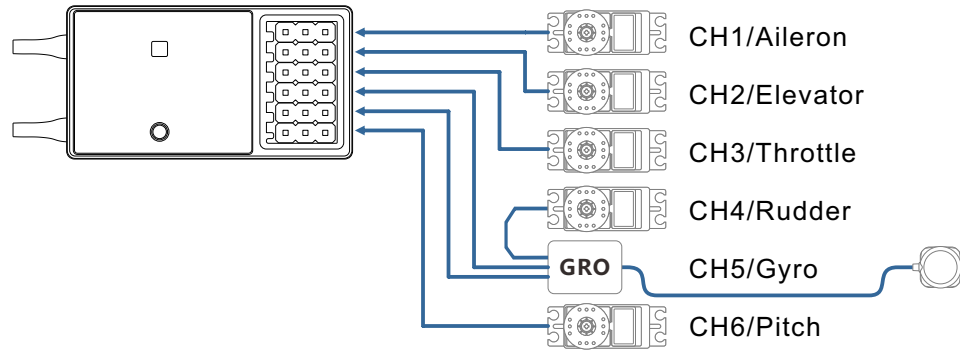

### Servo connection position (Helicopter, refer to stick mode "mode 1")

The table below shows examples of the servo connection positions for different swashes.

Type	Swash		CH1	CH2	CH3	CH4	CH5	CH6	CH7	CH8
Helicopter	H-1	Channel	AIL	ELE	THR	RUD	Gyro	PIT	AUX2	AUX3
		Control	J1	J3	J2	J4	--	J2	--	--
		Trim	T1	T3	T2	T4	--	--	--	--
	HR3	Channel	AIL	ELE	THR	RUD	Gyro	PIT	AUX2	AUX3
		Control	J1	J3	J2	J4	--	J2	--	--
		Trim	T1	T3	T2	T4	--	--	--	--

### Swash Types

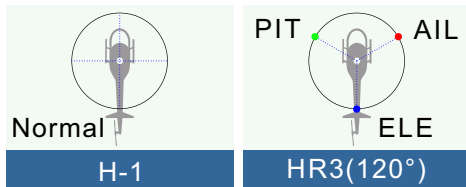

# Basic Operation

## Receiver and servo connection example - Multicopter

The figure below shows the four-rotor multicopter. Please refer to the model manual for specific applications. Motor, electronic speed controller, flight controller, battery, etc. are sold separately.

Use 5CH-6CH when using accessories such as camera shutters. Use a W.BUS interface or dual receiver when the channel is insufficient.

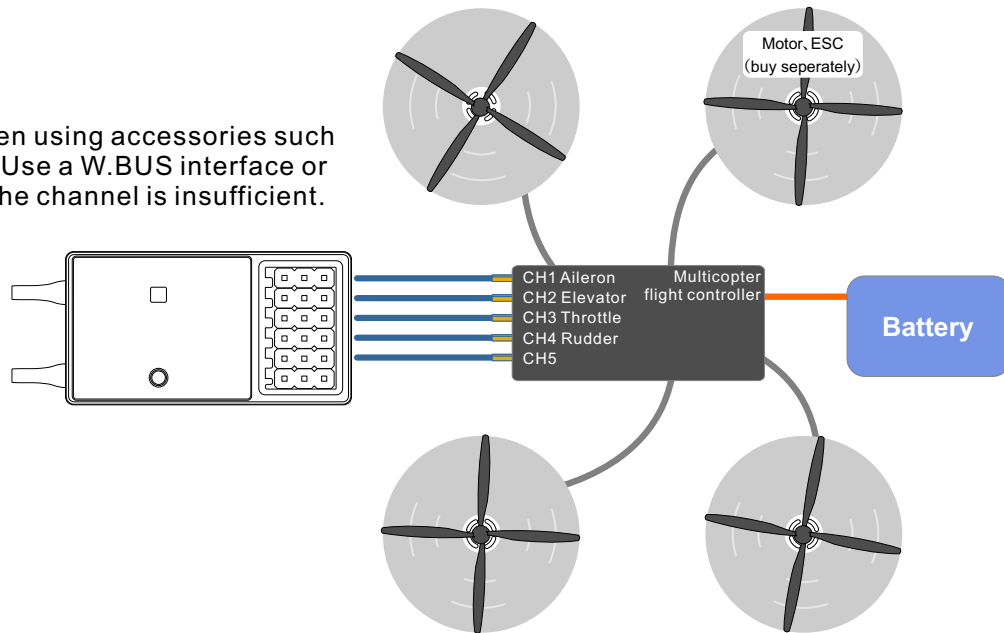

This figure is for illustrative purposes only. Link amplification also changes depending on the multicopter collective and the flight controller. Please connect according to the instruction manual of the multicopter kit to be used.

### Servo connection position (Multicopter, refer to stick mode "Mode 1")

Type		CH1	CH2	CH3	CH4	CH5	CH6	CH7	CH8
Multicopter	Channel	AIL	ELE	THR	RUD	Flight mode	AUX1	AUX2	AUX3
	Control	J1	J2	J3	J4	--	--	--	--
	Trim	T1	T2	T3	T4	--	--	--	--

## Basic setting sequence of airplane

### 1. Call of the model

The ET08 transmitter has 16 built-in models from the factory, and you can use the [MODEL SELECT] under [SYSTEM SETTING] to call up the existing model.

The Rename feature makes it easy to make a selection call to a model whose name has already been set.

The name of the model currently in use is displayed on the home page. Before flying and changing the parameter settings, be sure to determine if the correct model is selected.

When a new model is added, please select [MODEL TYPE] under [SYSTEM SETTING] according to the model used. If a new receiver is used, the receiver's link operation is also required [LINKAGE SETTING]-[LINK].

### 2. Model type selection

Use the [MODEL TYPE] function under [SYSTEM SETTING] to select the model type, wing type, and tail type that match the model airplane.

For example, the left and right azimuth servos can be selected from the main wing type by selecting "2 ailerons" and adjusting the two servos in [SUB-TRIM] and [END POINT] respectively.

### 3. The fuselage control part connect

Install the ailerons, elevators, throttles, rudders, etc. as required by the model aircraft product specification. For the connection method, refer to the "Receiver and Servo Connection Example - Airplane" (P16).

Note: ET08 transmitters have different channel assignments depending on the model type, so please pay special attention (in the [FUNCTION] option under [GENERAL MENU], you can check the allocation of each channel).

- If the direction of the actual connection is opposite to the direction you want, you can use [SERVO REVERSE] under [GENERAL MENU] to adjust the direction.
- Install the throttle section to ensure that the carburetor/electronic governor can be fully open or fully closed.
- Use the [END POINT] under [GENERAL MENU] to adjust the end point and rotation angle of each rudder surface, and use the [SUB-TRIM] function and the [END POINT] function to make fine adjustments. In order to protect the connecting rod, the stroke limit position can be set in the [END POINT] function item. [END POINT] function item can adjust the up and down or left and right movement amount of each rudder surface And limit.

### 4. Throttle Cut Setting (Airplane)

The [THROTTLE CUT] function allows us to turn off the engine by only one switch without affecting the throttle trim position (after idle adjustment).

\* When the [THROTTLE CUT] function is activated, the engine flame out position will be fixed. If the throttle cut switch is not required, use the [IDLE DOWN] setting function below.

Please use the [THROTTLE CUT] function option under [MODEL MENU] to set. After the flame out function is activated and the corresponding switch is selected, the throttle position will be adjusted until the carburetor is fully closed. For safety reasons, the activation position of the throttle lever position corresponding to the throttle stop function can be set separately.

### 5. Dual Rate Setting

[DUAL RATE] function is to match the feeling of control and adjust the rudder angle, which makes the control more convenient. The basic operating range of the steering gear is set in the [END POINT] function under [GENERAL MENU], and the steering feel is adjusted by the [DUAL RATE] ratio function of the [GENERAL MENU]. In addition, after setting the rudder angle ratio, it can also be switched by the switch or flight condition, and the flight action can be used to call up the set rudder angle.

### 6. Air brake

[AIR BRAKE] function is used when landing, etc., when the sliding angle is large but the speed is no need to be increased. This function can only be used on models with [SYSTEM SETTING] - [MODEL TYPE] and "2 Ailerons" on the wing.

\*Normally, the left and right ailerons are simultaneously set to the upward movement, and the pitch of the nose can be corrected by the elevator mixing when the function is started.

### 7. Flight conditions

The factory default setting assigns only one flight condition per model. Only one flight condition can support basic flight without barriers, but if you are in a competitive situation such as a game, you need more detailed settings. Through the [CONDITION] function in [MODEL MENU], you can select the required flight conditions more effectively. It can also be set for the switch of the condition switch and the name of the condition.

After the flight condition setting is completed, the switch needs to be operated, and the condition name displayed on the interface is confirmed.

## Basic setting sequence of the helicopter

### 1. Model addition and invocation

Please refer to the first part of the previous section "Basic Operation - Basic Settings of Airplane and Glider"

### 2. Model type and swash plate type selection

If you have already set up a model, use the [MODEL TYPE] selection interface to select the helicopter in [SYSTEM SETTING], and then select the helicopter "TYPE" and "SWASH TYPE" according to the model.

### 3. Flight conditions setting

The default setting contains the common mode (default naming) conditions.

There are 3 conditions that have been set.

- Normal
- Idle
- Hold

\*This switch is not set in the default settings

Examples of common flight conditions settings:

- Normal: (for default settings, switch off) usually used when starting or hovering.
- Idle: usually used when stall turn, somersault and other Idles.
- Hold: usually used in the spin state

The priority of these operation conditions is

- 1, Throttle Hold
- 2, Idle
- 3, Normal

### 4. Body control connecting rod installation

Install the throttle, tail rotor, aileron, elevator, pitch, etc. as required by the model helicopter product specification. The connection method can be referred to the "Receiver and Servo Link Example - Helicopter" (P17) section.

\* In the [FUNCTION] option under [GENERAL MENU], you can check the allocation of each channel.

- If the direction of the actual connection is opposite to the direction you want, you can use [SERVO REVERSE] under [GENERAL MENU] to adjust the direction. In addition to the H-1 mode, you can also change the direction using the [SWASH] function

- Set the direction of the gyroscope (this is the "Gyro" function)

- The throttle section should be installed to ensure that the carburetor can be completely closed when trim is fully closed.

- Use the [END POINT] under [GENERAL MENU] to adjust the ravel amount and rotation angle of each rudder surface, and use the [SUB-TRIM] function and the [END POINT] function to make fine adjustments. In order to protect the connecting rod, the travel limit position can be set in the [END POINT] function item.

The [END POINT] function item can adjust the up and down or left and right movement amount and limit of each rudder surface.

The swash calibration (except H-1 mode) can calibrate the swash motion by the correction mixing control of the [swash] function. This function is required when the pitch, aileron, and elevator operations cause the swash to deviate from the correct elbow.

In addition, the pitch of the link at the low point and the high point can also be calibrated, which is used to ensure the horizontal state of the swash in the full stroke range.

### 5. Throttle Curve, Pitch Curve setting

Bring up [THROTTLE CURVE] or [PITCH CURVE] from the [MODEL MENU] and set the curve for various flight conditions.

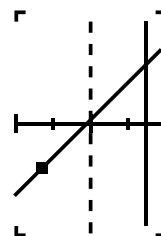

<Setting example>

Use the flight condition selection switch to bring up the throttle curve for each flight condition.

Throttle curve setting example is as follows:

- Throttle curve (Normal)

The normal curve uses a normal line type, and the basic pitch curve is set near the hover point (50% of the stick). This curve is usually adjusted with the pitch to ensure that the engine speed is uniform and the up/down action is easy to handle.

- Throttle curve (Idle)

This setting is to maintain stick rotate when the throttle lever is in the low position.

- Throttle curve (Hold)

Note: throttle hold curve is used for spin landing. Make sure the ratio of the lowest position (0%) of the throttle control lever is 0% (this is the initial setting).

Examples of pitch curve settings are as follows:

The pitch curve can be called up under each condition using the flight condition selection switch.

- Pitch curve (Normal)

In the pitch curve, the hover pitch is usually set to approximately  $+5^{\circ}$ ~ $+6^{\circ}$ . Under normal circumstances, the throttle stick is hovered at 50% position as the standard.

\* Stable hovering is also related to throttle curve setting. It is easier to achieve stable hover by using throttle curve adjustment and pitch curve adjustment.

- Pitch curve (Idle)

The pitch curve of the idle is usually used for flying through the air, and is generally set to  $-7^{\circ}$ ~ $+9^{\circ}$ .

- Pitch curve (HOLD)

In the throttle lock and spin drop conditions, the pitch should be set to the maximum in both the

## Basic setting sequence of the helicopter

positive and negative pitch directions. For example, from -7 to +12°.

### 6. Throttle Hold Setting

From the [MODEL MENU], call the [THROTTLE HOLD] function setting interface, and use the [FLIGHT MODE] switch to switch to the throttle hold condition interface.

Hold position setting: This function is used to set the working position (extinguish or idle position) of the servo under the throttle hold state.

THROTTLE HOLD	
STATUS	INH
SWITCH	--
HOLD POS.	17%
SPEED	0

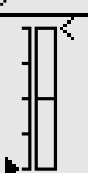

### 7. The Swash Mixing Controls the

Interaction of the Ailerons, Elevators and Paddles Through the [SWASH MIXING] under [MODEL MENU], the mixing ratio of each operation of the aileron, elevator, and pitch can be adjusted to ensure that the swash is corrected under each condition.

### 8. Throttle Mixing Setting

The swash aileron and elevator action will cause the engine speed to decrease. This phenomenon can be compensated by [THROTTLE MIXING] under [MODEL MENU]. In addition, the clockwise and counterclockwise torque changes can be compensated for when the body rotates.

GYRO		1/2
MODE	SWITCH	
POSITION	1	
SWITCH	--	
STATUS	OFF	

GYRO		2/2
TYPE	AVCS	
RATE	AVCS100%	
TUNING	--	
	20%	[20%]

### 9. Gyro Sensitivity Adjustment and Mode Switching

In the [GYRO] mixing function under [MODEL MENU], you can adjust the gyro sensitivity or mode switching for each condition or switch position.

- Normal (hover flight): The gyroscope is the most sensitive
- Idle 1 / Idle 2 / Throttle Hold: Gyro sensitivity is minimal.

### 10. Throttle Cut Setting

At the end of the flight, there is no need to change the position of the throttle trim, just turn off the engine by simply turning a flameout switch.

Set in the [THROTTLE CUT] function of [MODEL MENU]. Set the throttle lever to idle speed and adjust the rotation position of the flame extinguishing servo until the damper can be closed and the movement is unimpeded.

THROTTLE CUT	
STATUS	INH
SWITCH	--
CUT POS.	17%
THROTTLE	17%



\*The throttle trigger position can be set separately.

# SYSTEM SETTING

## MODEL SELECT

Interface path: HOME/MON. → [SYSTEM SETTING] → [MODEL SELECT]

The ET08 can store 16 sets of model data and flexibly edit and process the information of data set.

\*Example of model sending function (Requires two same types and same firmware versions remote controllers ,and with RF open):

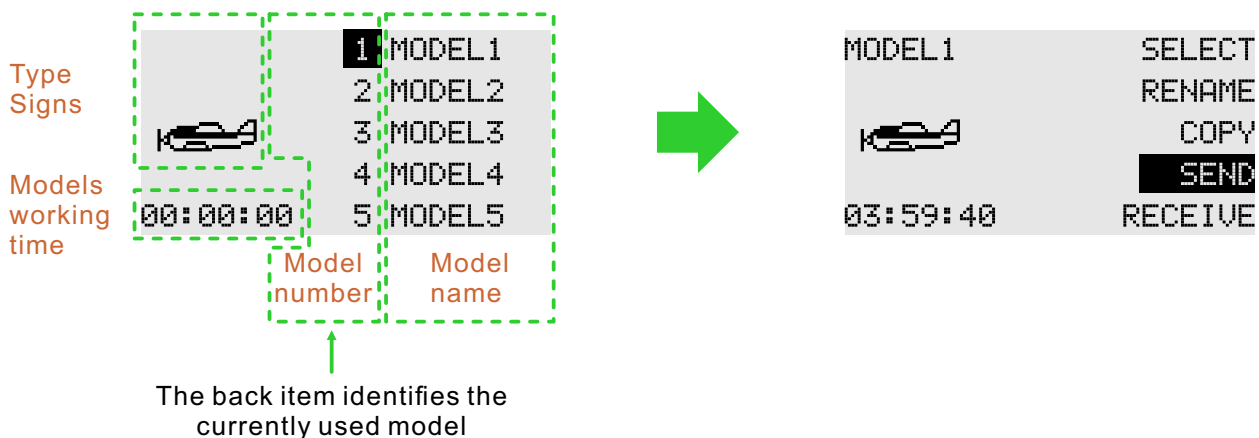

**Select:** Select the model to run, click the “Select” button on the right, and the selected model on the left will turn into a green bottom frame, indicating that the model is successfully selected. The currently running model (the model indicated by the green box) will be displayed in the main interface.

**Rename:** You can rename the selection (the box flashes) The model name is nine characters long and only supports English naming. Model group.

**Copy:** The selected model copies (overwrites) the data of another model to back up the model data, or to quickly add and configure models that are not very different.

**Send:** Share the selected model data. The selected model data is sent to another ET08.

**Receive:** The location of the selected model to receive and store model data shared by another ET08.

\*The model name is with 8 characters and only supports English naming.

### Model selection example (Switch to the model that needs to be operated):

The selected model becomes a blue bottom frame. Click the “OK” button of the five-way button or touch the screen to directly click on the model, the selected model flashes, and the right operation option pops up. Pay attention to the model group name when copying the model to avoid erroneous operations.

### The operation of transmitting the model data by the No. 1 remote controller and receiving the model data by the No. 2 remote controller:

- No.1 remote control: Click to select the model group data to be shared (such as “Model 1”), select the “Send” button displayed on the right interface, click to select “Yes” in the pop-up window, and the model group data is waiting to be received.

- No.2 remote control: firstly select the saved model group position, select an unset model in the left model list and click, the right interface displays the “receive” button, click, and the prompt pop-up window selects “yes”. The second remote control starts receiving model group data

\* The transmitter order relation of “Transmitter”and “Receiver”function: when operate this function. firstly operate “transmitter”then operate “receiver”

\* Sending and receiving operation distance should be within 0.5 meters.

### NOTICE

The “copy” function, the target model data is covered by the reference model data. Please confirm that the target model data is no longer needed and then do the copy operation.

MODEL COPY	
SOURCE	OBJECT
MODEL 1	MODEL 2
COPY	

# SYSTEM SETTING

## MODEL TYPE

Interface path: HOME/MON. → [SYSTEM SETTING] → [MODEL TYPE]

Airplanes are available in 3 main wing types and 3 tail types. Helicopters can be chosen 2 swash types. There is a default preset for each type of model data

Model type: helicopter, airplane, multicopter

Helicopter swash: H-1, HR3 (120°).

Wing Types (Airplane, glider):

- Wing: 1 aileron, 2 ailerons, delta wing  
- Tail: Normal, V-tail, Ailvator; normal, winglet (delta wing).

Save setting: After the type is selected, click the "OK" button in the lower right corner to save the settings.

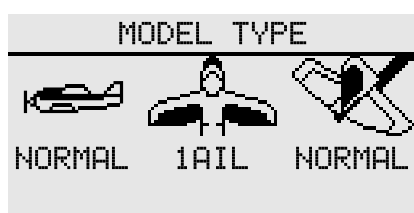

When setting "MODEL TYPE", the selection interface will pop up successively to complete the type selection. If you do not select "ok" to save the operation and return to the parent interface, the changes are not saved.

### Example of operation: setting the model to helicopter (HR3)

1 Select "MODEL TYPE" to pop up the model type list.

2 Select "Helicopter" to bring up the swash list.

3 Select "HR3" to return to the default [MODEL TYPE] interface, and click the "OK" button to save the changes. Finish setting!

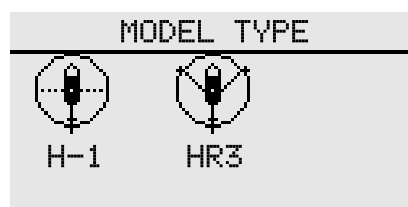
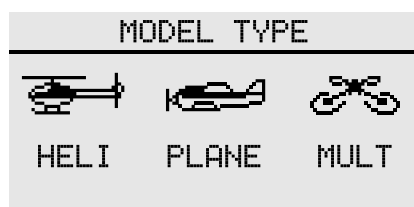

### NOTICE

When the "MODEL TYPE" is replaced ( **the data in current model will be cleared!** ), the model data reset as factory configuration of the new model. Therefore, you must confirm that you do not need these data, or use the [MODEL SELECT] function to "copy" the backup of the model data, and then do the replacement operation. Same as above, such as "SWASH", "Wing Type" and "Tail Type" operation, the corresponding operation will clear and change the current model data to the default parameters of the newly selected type, so it is necessary to reset the model function of [SYSTEM SETTING] .

# SYSTEM SETTING

## TRAINER

Interface Path: HOME/MON. → [SYSTEM SETTING] → [TRAINER]

Trainers can assist students in learning flight skills and improving flight levels based on their flight experience and operational level. A special trainer line (sold separately) is required between the trainer and the trainer to connect. The trainer must turn on the trainer mode before the trainer can be operated.

When the trainer switch is turned off, it will return to the trainer transmitter to control the flight. When the student machine flight is dangerous or the deviation is too large, the trainer can be switched immediately to ensure safety

When using the WFT08/09 as a trainer, please purchase a universal analog patch cord, 3.5mm male to male audio cable. (The coaching line and audio cable need to be purchased separately. Two cores and three cores are available.)

TRAINER		1/3
MODE	TRAINER	
SWITCH	--	
1AIL	ON	
2ELE	ON	



Trainer mode



Simulator mode



Student mode

- Normal: default mode
  - Trainer: Control transmitter;
  - Simulator: When the flight is practiced through the computer-side simulator, the RF is turned off, reducing power consumption. To extend the working hours of the transmitter;
  - Students: Turn off RF transmission, only the trainer turn on the Trainer switch can trainer channel could be controlled! (Example: The trainer model has only three channels: aileron, direction and gyro, so the student can only control these three channels when the trainer turn on the trainer switch. )
- Trainer Switch: Default [--]
- Status: Each channel status switch of trainer. Turn on, students can be controlled; off, students Uncontrollable

\*The following trainer functions take the same model as an example.

### Trainer Setting:

Mode → Trainer, choose control switch, channel  
status → Turn on with demand

\* The channel defaults to full on, and the visual model and actual application are adjusted.

### Student Setting:

Mode-Student.

### NOTICE

Make sure that all channels of the Trainer and student can be controlled properly before flying. Make sure that the connector of the trainer line is inserted firmly to avoid looseness.



# SYSTEM SETTING

## DISPLAY

Interface Path: HOME/MON. → [SYSTEM SETTING] → [DISPLAY]

Adjust the brightness of the display backlight, the shutdown time, and the lock screen time to adapt to different environments and energy saving.

DISPLAY 1/2	
CONTRAST	7
BRIGHTNESS	10
TIME	30 SEC
AUTO LOCK	NEVER

DISPLAY 2/2	
AUTO OFF	NEVER

Contrast: sharpness adjustment.

Backlight: brightness value.

Backlight time: system backlight time!

Automatic lock screen time: lock screen after touching the screen without any operation.

Automatic shutdown time: transmitter shutdown after no operation time

---

### Parameter Value Setting:

Backlight time, default 30 seconds, 15 seconds, 30 seconds, 1 minute, 2 minutes, 5 minutes, 10 minutes, never off.

Auto power off time, default off, 30 minutes, 40, 50, 60 minutes, off

Automatic lock screen time, default off, 15 seconds, 30 seconds, 1 minute, 2 minutes, 5 minutes, 10 minutes, off

### WARNING

High brightness display will increase the energy consumption of the transmitter, which will affect the working time of the transmitter. Please pay attention to setting the transmitter voltage alarm. Pay attention to the battery level and avoid low battery.

## USER NAME

Interface path: HOME/MON. → [SYSTEM SETTING] → [USER NAME]

The model name can be user-defined.



# SYSTEM SETTING

## LOW BATTERY

Interface path: HOME/MON. → [SYSTEM SETTING] → [LOW BATTERY]

By setting the alarm trigger value, an alarm is given at low voltage. Avoid accidents caused by long-term operation of the control system under low voltage conditions.

LOW BATTERY	
TRANSMITTER	3.7V
RECEIVER	4.2V
EXTERNAL	0.0V
CALIBRATION	

(beep-beep-beep)  
Set battery voltage alarm value. (beep beep beep-beep beep beep-beep beep beep- beep beep beep beep beep-beep beep beep beep beep)

Set battery voltage detection reference voltage

### NOTICE

When the alarm sounds, please pay attention to what type of warning is displayed on the screen at the right time ASAP to avoid running in an abnormal state for a long time!

#### Parameters Setting (transmitter alarm value):

Click the "Transmitter" value box and click the parameter adjustment button according to factors such as battery life and performance.

Transmitter, default 3.7V, range: 3.5-6V.

Receiver, default 4.2V, range: 3.8-6.5V.

External voltage, default 0V, range: 0-36V.

\*The above data defaults to lithium battery. For other battery types, please refer to the battery's instruction manual.

# SYSTEM SETTING

## SOUND

Interface path: HOME/MON. → [SYSTEM SETTING] → [SOUND]

The sound helps the flight process to notice various anomalies or planned audible prompts.

SOUND		
WARNING	ON	—  WARNING: Voltage alarm prompt
TRIM	ON	—  TRIM: Trim operate sound prompt
TIMER	ON	—  Timer: On or off timer sound prompt
OTHER	ON	—  Other: Button, knob over the middle point, etc

### WARNING

To ensure safe operation, be sure to turn on the Sound!

## LANGUAGE

Interface path: HOME/MON. → [SYSTEM SETTING] → [LANGUAGE]

Select the language displayed on the interface, ET08 provides Chinese and English display.



# SYSTEM SETTING

## STICK MODE

Interface path: HOME/MON. → [SYSTEM SETTING] → [STICK MODE]

Provides 4 operating mode options, in addition to the [Function] user defined the mode.

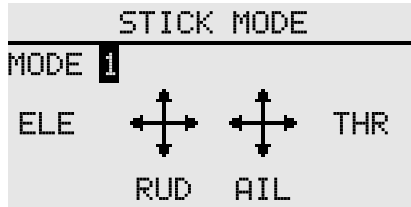

— Click "OK" to switch modes

### NOTICE

Change the stick mode, which notice involves the [FUNCTION] content.

# SYSTEM SETTING

## CALIBRATION

Interface path: HOME/MON. → [SYSTEM SETTING] → [CALIBRATION]

The stick has been calibrated at the factory. If the center position of the stick changes, you need to use this function to calibrate the stick.

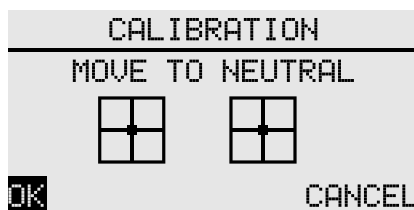
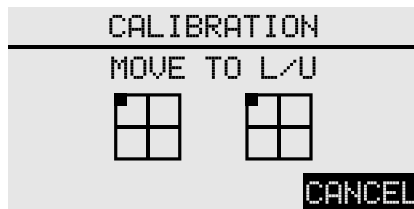
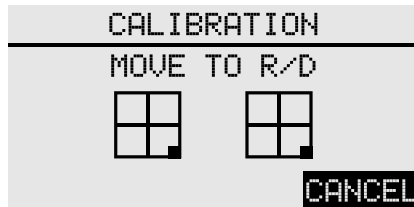
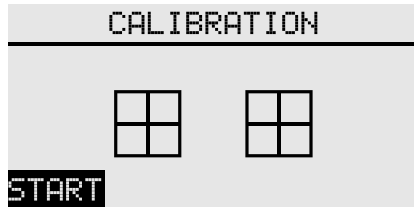

Click OK to save the NEUTRAL position!

### DANGER

System security: Calibration performed under the connection state of the receiver may cause wrong operation, must disconnect model connection!

### NOTICE

For calibration, please refer to the scale of the assembly surface for alignment! If the calibration process cancels or exits the function interface, the calibration is invalid!

The system automatically identifies the stick position, and start the next action prompt.

# SYSTEM SETTING

## DATA RESET

Interface path: HOME/MON. → [SSYTEM SETTING] → [DATA RESET]

Reset the transmitter's selected parameter settings. The "Factory Reset" operation is with large amount of data, please be patient when performing this operation.

### NOTICE

This function will clear the exist model data!

#### DATA RESET

MODEL MENU SETTING

ALL MODEL SETTING

FACTORY SETTING

All settings under (MODEL MENU) would be reset to the default data.

All chosen model data will be reset to the default data

All data from the transmitter will be reset to the factory data. Includes System Setting, Linkage Setting, General Menu , and Model Menu



## INFORMATION

Interface path: HOME/MON. → [SYSTEM SETTING] → [INFORMATION]

Displays system version information and system upgrade entries. There is also the Official WeChat of WFLY, which uses WeChat to scan and add attention. Send "ET08 upgrade package", you can view or download related information.

### Upgrade

The upgrade process requires the use of a computer (currently supports WINDOWS system WINXP\7\8\10), the main steps are as follows:

- 1 Drive installation
- 2 Transmitter upgrade
- 3 Verify the upgrade

### Upgrade package obtain method

1 Official website download. Log on to [www.wflysz.com](http://www.wflysz.com), click on the ET08 product page, click on "Support Downloads" at the top of the product description, find the relevant download link, and click the download button on the right to download.

2 WeChat PC side download. Log in to WeChat, open the "WFLY" WeChat official account, send the text "ET08 upgrade package", you will receive the download link of the latest upgrade toolkit, click the driver link, you can directly download and save to the PC.

For specific installation methods, please refer to the instructions in the upgrade package, or visit the official website to view the upgrade instructions in the ET08 model "Frequently Asked Questions" under "Technical Support".

Please contact customer service, If you can't install the machine!

INFORMATION 1/2	
TYPE	ET08
VERSION	V0.0.01
ID	05DFFF32
UPGRADE	



### NOTICE

Please ensure that the transmitter is fully charged during the upgrade process.

### WARNING

The wrong upgrade pack will render the machine unusable and unable to force an upgrade.

\*The upgrade kit version number varies according to the downloaded version

## SCREEN LOCK SET

Interface path: HOME/MON. → [SYSTEM SETTING] → [SCREEN LOCK SET]

Set the enable condition of "5-way key/CURSOR", "menu/exit" and "trim" buttons in the lock screen state.

Press and hold "EXIT/LOCK"key to operate screen lock and unlock.

5-way key/cursor:lock 5-way key function when screen lock.

MENU/EXIT: Lock "HOME/MON.", "EXIT/LOCK"key when screen lock.

TRIM: Lock T1-T4 trim key when screen lock.

SCREEN LOCK SET	
CURSOR	ON
MENU/EXIT	OFF
TRIM	OFF

# LINKAGE SETTING

## LINK

Interface path: HOME/MON.→[LINKAGE SETTING]→[LINK]

The link function is used for matching the transmitter and receiver.

LINK	
TELEMETRY	ACT
MODE	MODE A
LINK	START

Telemetry: Data backhaul function. Mainly used for functional judgment and data analysis, shutdown telemetry will affect the use of security functions. The default Telemetry is on, it is recommended to turn on!

Mode: Working mode selection(default working mode A). Please refer to the table on the right. The channel marked in the table is defined as the default configuration. You can customize the channel by [RECEIVER OUTPUT].

Receiver channel definition(Connect RF206S)

Receiver slot	Channel User defined
	Model A/B
1	1
2	2
3	3
4	4
5	5
6	6

Receiver channel definition(RF207S/09S)

Receiver slot	Channel User defined	
	Model A	Model B
1	1	7
2	2	8
3	3	3
4	4	9
5	5	10
6	6	11
7	7	12
8	W.BUS/PPM	W.BUS/PPM
9	W.BUS2	W.BUS2

Link: Immediately link the transmitter and receiver. Clicking link will bring up the confirmation box

### Link steps (default working mode A)

- 1, Transmitter, enter into the menu [LINKAGE SETTING] → [LINK], standby.
- 2, Charge the receiver, pressed SET button for 3 seconds, the LED orange light flashes.
- 3, Transmitter, the telemetry function is default, click the Link of "Start" button, the RF light flashes.
4. Verify the Link method:
  - 1 Successfully linked, and the receiver LED light turns to solid green.
  - 2 Connect to the servo, operate the transmitter, when the corresponding servo has synchronous output action it means link successfully.

### WARNING

When linking, please be careful not to connect the power equipment, and remove the propeller, pay attention to safety! To ensure safety, please do not link in the status where the motor and engine are running.

### NOTICE

1. The transmitter and receiver must be close to each other (less than 1 meter);
2. The transmitter cannot perform link operation in the simulator and student mode ([SYSTEM SETTING] → [TRAINER] to set);
3. There is no other WFLY 2.4GHz system in progress.
4. In the process of linking, if you need to exit the link, click the "Cancel" button or press the Back button.
5. After finished the link, the connection verification must be performed.
6. Telemetry: Disabling this function when link will affect the use of [RANGE CHECK] [LOW BATTERY] [BUS SERVO SETTING] [TELEMETRY], Etc.

## TELEMETRY

Interface path: HOME/MON.→[LINKAGE SETTING]→[TELEMETRY]

The telemetry interface displays the receiver's return data.

TELEMETRY	
RECEIVER	4.2V
EXTERNAL	12.6V

### NOTICE

Disabling the "Telemetry" function when linking will affect the use of [RANGE CHECK] [LOW BATTERY ] [BUS SERVO SETTING] and [TELEMETRY] ect.

# LINKAGE SETTING

## PPM/W.BUS

Interface path: HOME/MON. → [LINKAGE SETTING] → [PPM/W.BUS]

Switch the receiver PPM/W.BUS output mode.

\* Different receivers, different ports.

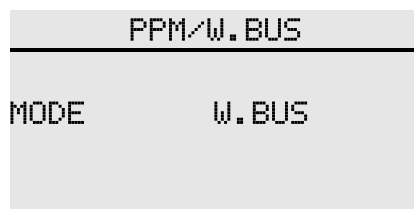

PPM mode. The 6th port of the RF206S outputs with a standard 4096 resolution and 8 channel PPM signal.

W.BUS mode is compatible with S.BUS signal.

---

### Switching the 6th port mode of the receiver:

1 When the receiver is connected, click the mode button to switch the mode, click the function title in the upper left corner to return to the previous menu and save the changes.

2 Please refer to the "Receiver manual instruction" section (page 15) "PPM/W.BUS Interface Operation Mode Selection", and the receiver can also directly switch the 6-port mode.

\* After the switch is completed, the receiver status lamp can be used to check whether it is successful. (refer to receiver operating status table).

# LINKAGE SETTING

## RECEIVER OUTPUT

Interface path: HOME/MON. → [LINKAGE SETTING] → [RECEIVER OUTPUT]

This function is used to customize the port output function channel of the receiver. For the corresponding channel function, please go to [Function] of [General Menu] to set.

Different receivers will have different Settings and the default Settings will be different.

**All ports of RF206S can be customized channels, but PPM and W.BUS can only be set to the 6th port.**

Note: [RECEIVER OUTPUT] needs to be set with only one receiver connected.

RECEIVER OUTPUT 1/2			
PORT	CH	PORT	CH
1	1	4	4
2	2	5	5
3	3	6	6

RECEIVER OUTPUT 1/2			
PORT	CH	PORT	CH
1	7	4	9
2	8	5	10
3	3	6	11

RECEIVER OUTPUT 2/2			
PORT	CH		
7	7		
8	8		
9	9	RESET	

RECEIVER OUTPUT 2/2			
PORT	CH		
7	12		
8	W.BUS		
9	W.BUS2	RESET	

Mode A (RF209S)

Mode B (RF209S)

---

### Port setting instructions:

- 1 As shown above, port 1, the system defaults to channel 1, you can also set to 2-18 channels.
- 2 The Reset button resets all ports to their default configuration.

**\*Set the receiver to be connected, enter the interface to read the current receiver parameters, exit the interface and save the current receiver settings.**

# LINKAGE SETTING

## FAIL SAFE

Interface path: HOME/MON.→ [LINKAGE SETTING] → [FAIL SAFE]

With this function, when the receiver cannot receive the signal normally, it will automatically run, and the servo rocker arm will move to the preset position (preset action). Used to protect aircraft and reduce unnecessary losses.

For each channel, three protection modes can be set.

1 Hold: Hold mode, the servos remain unchanged in the last operating position before fail safe. (keep the action).

2 F/S: Fail Safe mode, after the controller is under fail safe, the servo is rotated to the preset position (preset action).

3 Off : Turns off the current channel output. (Only for some special models or some of the flight control board detection ports)

	FAIL SAFE	1/2
1 AIL	OFF	
2 ELE	HOLD	
3 THR	F/S	0%
4 RUD	F/S	0%

F/S value: Click the corresponding key to the value or press the confirm key to get the current stick or switch position parameters. (F/S value can only be displayed and set in F/S mode)

### WARNING

For your safety, be sure to set up fail safe protection. Especially the Fail Safe of the throttle channel. In that way, the airplane flight speed is reduced and the helicopter is decelerated from the hovering state. It is very dangerous to drop the plane at high speed due to fail safe.

### ! Mandatory

If your operation does not allow the model to move in an unexpected pose, be sure to land the monitor to check the receiver's battery or the body.

Reference:

Model fail safe is very dangerous, so you should be careful when setting this function, you can refer to the following suggestions, or send an email to [service@wflysz.com](mailto:service@wflysz.com) or add Skype/WeChat/WhatsApp account: +86-189 2382 0083.

Setting reference (only recommended settings, please set according to your actual flight situation):

1. The helicopter throttle is set to the lowest value, and the remaining channels are set to run smoothly.
2. The airplane/glider throttle is set to the lowest or low idle speed, and the other channels are set to run smoothly (or hovering), because the airplane/glider can slide down without power.
3. Please refer to the flight control manual for multicopters.

### Parameter value setting (Example: Airplane 3 channel value setting Fail Safe):

Model setting requirements: Airplane channel 3 defaults to throttle channel, we need to slow down the glide after the model loses signal.

Operation: Click the button on the right side of channel 3 to switch to "F/S" mode. The value button appears on the right side of the button, and the transmitter throttle channel hits the lowest.

When the throttle position is selected, click the value button of channel 3 (or click the confirmation button when the cursor is on the channel 3 value button) to set the current channel action.

\* The action preset for the specific runaway protection is related to the actual model. Please check the model manual. (Settings need to be connected to the receiver.)

When exiting this operation interface [Fail Safe]

All the parameters set are automatically saved to the receiver)

Additional protection features:

The ET08 provides active protection. As long as the telemetry function is turned on, as long as the RF206S receiver is still powered on, the transmitter needs to be confirmed to shut down! It can prevent the receiver from inadvertently shutting down and actively enter the F/S state, so that the model can make unexpected and dangerous actions to avoid loss and damage.

# LINKAGE SETTING

## RELAY FLIGHT

Interface path: HOME/MON. → [LINKAGE SETTING] → [RELAY FLIGHT]

This function is a flight control mode that uses two transmitters, two receivers, and one model aircraft to achieve long-distance relay control. The main and the sub-transmitter are linked separately with the receiver, the eighth pin header (PPM/W.BUS) of the sub-receiver RF209S connect with the ninth pin header of the main receiver.

(W.BUS2) connection. The host transmitter is in the [HOME/MON.] - [Linkage Setting] - [Relay Flight] - Enable function and set the signal control switch.

RELAY FLIGHT	
STATUS	INH
SWITCH	--

Status: Set relay flight function enable/disable. (The setting is valid only when the receiver is connected)

Switch: Set the control signal switch. (When the switch is ON, it is controlled by the subtransmitter. When the switch is OFF, the signal is controlled by the main transmitter)

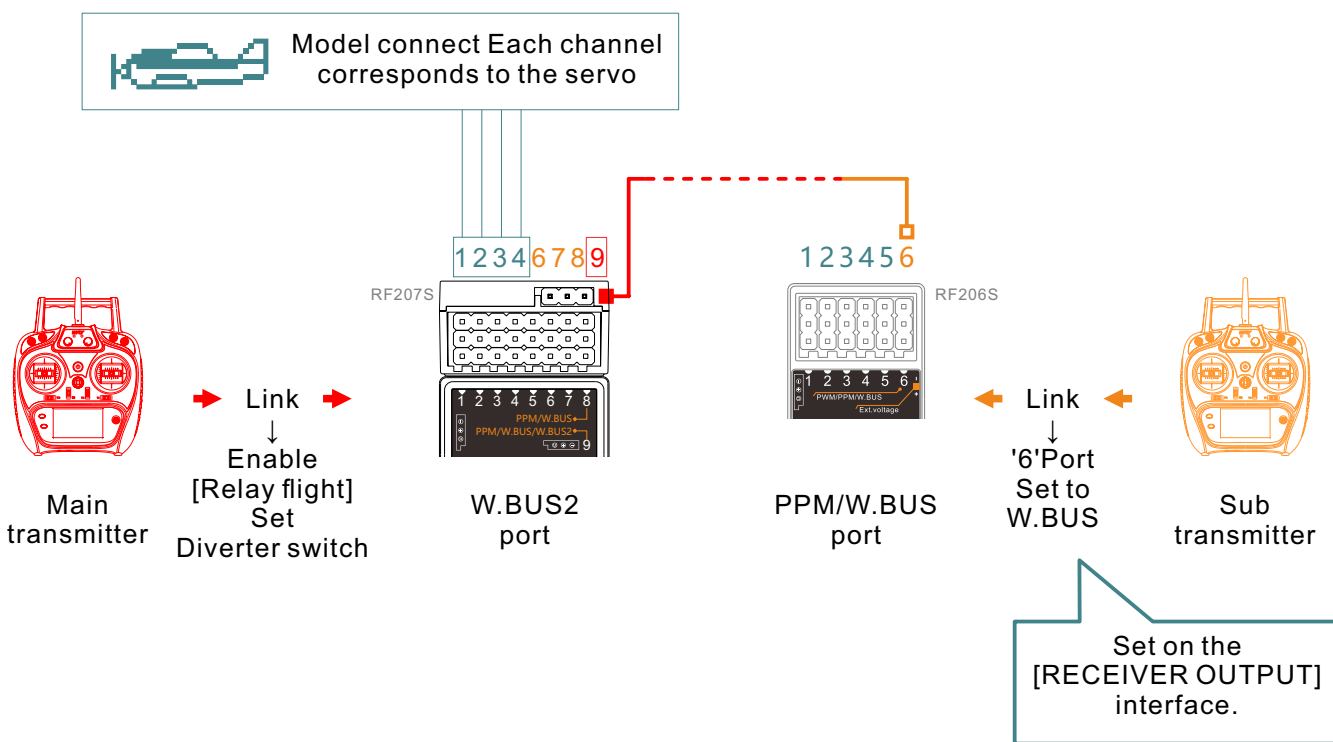

\* [Relay Flight] function only needs to be enabled by the main transmitter setting function. The sub-transmitter does not need to be set to [Relay Flight].

\* [Relay Flight] need the support of receiver W.BUS!(such as RF207S/RF209S are with W.BUS port.)



## SERVO FREQUENCY

Interface path:HOME/MON.→ [LINKAGE SETTING] → [SERVO FREQUENCY]

When using the digital servo, adjust the receiver output frequency to match the operating frequency of the servo to better play the servo performance.

Adjust the output frequency of the receiver, the stroke is 50Hz~300Hz, and the setting is successful when exiting

SERVO FREQUENCY	
VAULE	50Hz

### NOTICE

This function requires servo support and requires the transmitter and receiver to be in normal communication state for the settings to be effective! The system defaults to 50Hz. Do not change the servo frequency parameters at random. Otherwise there is the possibility of damage to the servo!

# LINKAGE SETTING

## BUS SERVO SETTING

Interface path: HOME/MON. → [LINKAGE SETTING] → [BUS SERVO SETTING]

\* This function needs the support of receiver which is with W.BUS! (such as RF207S/RF209S are with W.BUS port.)

The BUS servo can memorize its own channel and different settings. The servo can be configured on the ET08 by connecting the servo via the W.BUS2 receiver interface. (WFLY W.BUS system is compatible with S.BUS servos !)

Notice:

1 Before using this function, you need to enable the [Telemetry] function and the receiver is connected normally.

2 When setting, only one BUS servo can be connected for setting at a time.

3 When using the BUS servo, ensure that the power supply is sufficient, otherwise the servo will have an abnormal situation such as unstable output!

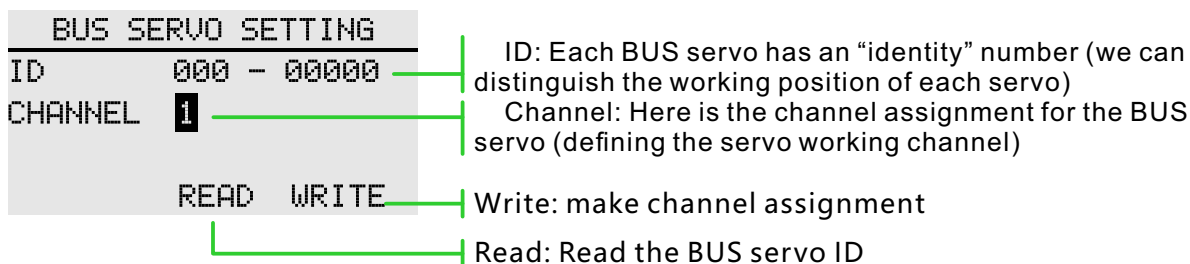

**Setting method:** The use of W.BUS function is mainly to allocate channel parameters for BUS servo, which is divided into three main steps.

**Prerequisite:** The transmitter and receiver are linked (turn on telemetry) and communicate normally.

First, read the BUS servo ID.

Connect the BUS servo to the "W.BUS2 slot" of the receiver and the transmitter clicks the "Read" button.

Second, the channel allocation.

In the "Channel" setting item, select the corresponding channel according to the function of the servo. Click the "Write" button, set the servo channel and complete the parameter saving, and exit the setting interface.

Third, verify the steering gear channel.

Turn on the monitor, connect the servo to the "PPM/W.BUS" interface, and operate the joystick or switch knob (currently connected to the channel set by the servo).

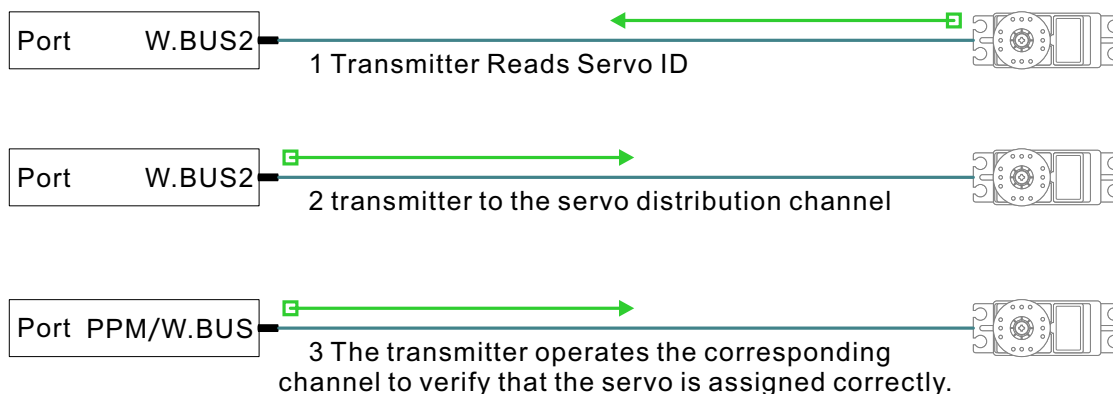

## 180/270°SERVO

Interface path: HOME/MON. → [LINKAGE SETTING] → [180/270°SERVO]

The 180/270° servo is the setting of the rotary stroke of the large rudder angle servo, which is disabled by default.

It is generally used in the setting of a large amount of servo such as a tank or a robot.



---

\* This function needs to be connected to the receiver before it can be set.

### NOTICE

Enabling the large rudder angle may cause the servo to move beyond the rotation stroke and damage the servo. Therefore, before using this function, be sure to check if the servo is suitable for this function.

# LINKAGE SETTING

## RANGE CHECK

Interface path: HOME/MON. → [LINKGE SETTING] → [RANGE CHECK]

The range check is mainly used to test the distance

Turn on the telemetry when linking. After linked, the transmitter receiver can be connected normally to use this function! Only enter this interface, after toggling the SH switch, the power will be reduced!

The control distance is related to the actual use environment!

```
RANGE CHECK
PULL [SD] TO REDUCE
THE POWER OF TX.
POWER IS NORMAL
SIGNAL STRENGTH 100%
```

### Instructions:

1. Enter the interface and toggle the SH switch.
2. The transmitter and receiver maintain a certain height (about 1.5 meters above the ground) and the antennas are in the same direction (perpendicular to the ground).
3. The transmitter and receiver are powered, start moving position, and move the stick.
4. The transmitter checks the signal strength on the interface, and the receiver checks whether the status light and the servo dual rate are smooth. The above bring the comprehensive evaluation of the working distance!

### Signal strength judgment:

The transmitter signal strength returned by the receiver can be viewed in the upper right corner of the screen status bar (the standby interface during normal operation) and the signal strength percentage indication ([Range Test] function interface). The more indicator bars, the larger the percentage value. The better the signal, conversely, the worse signal. The status bar has no signal bar indication, and there is no signal when the signal strength is 0%.

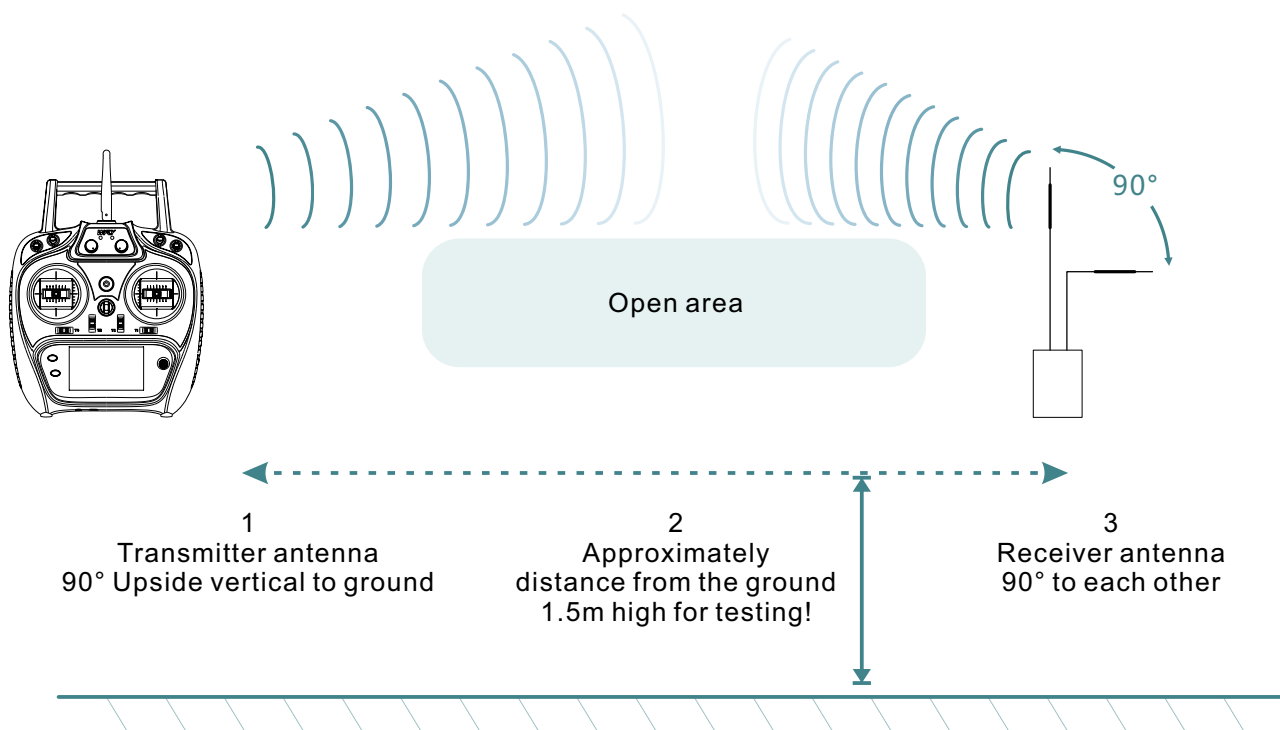

\* [RAGE TEST] The results are for reference only and are not intended as the only performance standard, depending on the specific usage environment!

## MONITOR

Interface path: HOME/MON. → [GENERAL MENU] → [MONITOR]

This interface can be used to understand the servo output of each channel and confirm the servo action. It can also perform the servo test, such as "stroke" and "Midpoint Test".

Operating Mode:

- OFF: The default item displays the real-time output position of all current channels.
- "NEUT" mode: Neutral, all channels, the rudder opportunity is fixed at the midpoint stroke position.
- "MOV" mode: Movement, all channels, rudder opportunities repeatedly.

Throttle: The throttle channel is closed by default, avoiding the throttle channel action output in case of causing danger.



### DANGER

Never use the servo test mode when the motor is connected or the engine is in the start state. (It is very dangerous to cause the propeller or rotor to rotate.)

### WARNING

In dynamic mode, each rudder moves at an angle set by the rudder angle, so do not perform this test while connected to the body. (It may cause damage to the servo or connector or even the body.)

### Monitor Application:

- 1 Servo action (channel) output real-time dynamic viewing.
- 2 Test of the end and midpoint of the servo stroke.

### Servo test function:

- 1 Midpoint mode: All channels (servo) are at the neutral point, and the midpoint of the servo of each channel can be fine-tuned, thereby fine-tuning the model.
- 2 Dynamic mode: All channels (servo) are cycled back and forth between the two ends, and the stroke adjustment is made, so that it is possible to adjust whether the magnitude of the motion of the servo of each channel is suitable for the model.

# GENERAL MENU

## FUNCTION

Interface path: HOME/MON. → [GENERAL MENU] → [FUNCTION]

When selecting the model and wing type, the servo output channel and function combination has been preset. If necessary, you can change the servo output.

The combination of the road, functions (ailerons, elevators, etc.), control (stick J1-J4, switch SA-SH, trimming T1-T6, lever) and corresponding trimming can be customized.

Channel: When channel switching is used, the current channel will be replaced, and the replaced channel will automatically change the setting data (stroke adjustment, neutral point trimming, servo reverse, fail safe, etc.). (You can specify the same function to different servo output channels, such as assigning elevators Go to channel 2 [CH2] and channel 3 [CH3].)

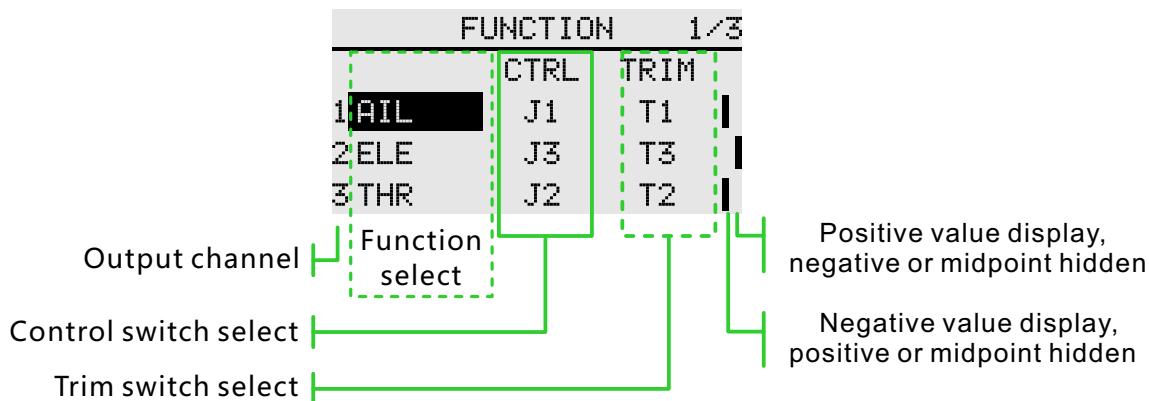

Click the button on the left as shown in the figure below to pop up the channel function selection interface, click the button on elevator to pop up the confirmation window, and select "yes" to save the Settings.

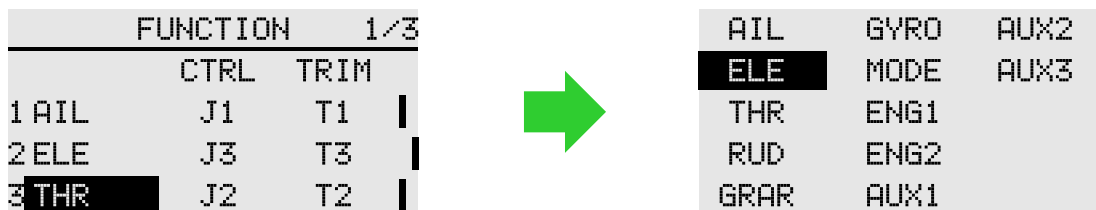

### NOTICE

After the [Function] function is adjusted, you may need to adjust the following parameters: [End Point],[Sub-trim ], [Servo Reverse], [Fail Safe], etc.

## SERVO REVERSE

Interface path: HOME/MON. → [GENERAL MENU] → [SERVO REVERSE]

This function reverses the direction of motion of each channel servo.

For helicopters with a swash structure (HR-3, etc.), first use [Servo Reverse] to match the direction of the pitch servo, and then use the swash AFR function to set the direction of the ailerons and elevators.

In some airplane/glider mixing settings, multiple servos control the same function. Whether to reverse the airplane or reverse the function setting is very complicated and difficult to distinguish. For specific functions, be sure to perform adequate physical inspection before flying.

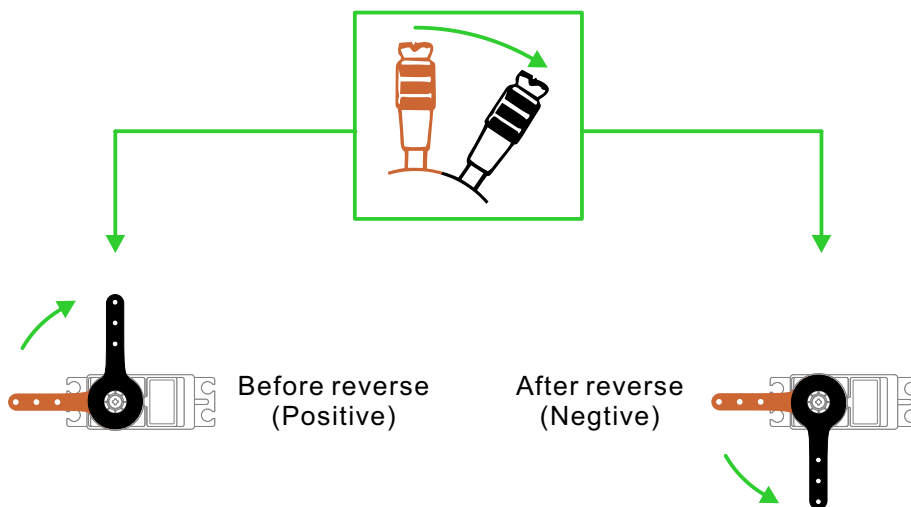
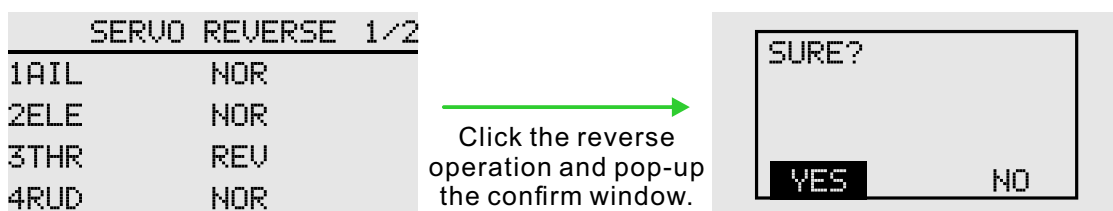

**WARNING** Before each flight, carefully check whether the system type, model type, steering action, direction of motion, and switch settings are correct or not.

**DANGER** The throttle channel (3CH) is reversed at the initial setting. Please carefully check the throttle direction of the engine and motor, taking care not to suddenly turn on the power at full speed. When using an electric model, please do not care if the propeller or rotor is not installed. Identify the direction of movement of the electric and stick. Connecting a propeller or a rotor can easily cause accidental rotation and lead to serious dangers such as injury.

## DUAL RATE

Interface path: HOME/MON. → [GENERAL MANU] → [DUAL RATE]

The function can set the rudder angle end point and action curve of CH1-CH8 channel, which can be adjusted separately for each condition. This function is usually used after setting the servo stroke. When mixing is applied from one channel to another, both channels can use the [Dual Rate] function to change the operating ratio

Channel: CH1-CH8 channels can be set.

Mode: Flight conditions, switch, Two control modes. The "Flight Mode" mode is controlled by the [General Menu] function setting switch.

DUAL RATE		1/2		
CHANNEL	AIL			
MODE	SWITCH			
POS.		1	2	3
SWITCH		--	--	--

DUAL RATE				
1AIL		5GEAR		
2ELE		6AUX1		
3THR				
4RUD				

DUAL RATE		1/2		
CHANNEL	AIL			
MODE	SWITCH			
POS.		1	2	3
SWITCH		SA	--	--

Curves 1, 2, 3: The curve control switch can be freely distributed, and the effective priority level is the optimal level with large numbers (3 is preferred)

1: Default curve, valid when other switches are not activated. Can be set when other numbering curve control switches are not activated.

### Example of curve setting for the corresponding switch (setting the curve of the switch of 2):

1 Assign control switch: Select the "--" option under "2" in the interface (above), pop up the [Switch Assignment] interface, select the control switch and select the active position. (For example, the 2nd position of the switch SA is the active position: the upper and lower buttons select SA to press the confirm button, the SA option flashes and jumps to the "switch" gear setting item, press the confirm button to open the gear position setting, the up and down keys select the 2 gear position, press Confirm the key switch activation condition is "On", press the return key twice to save the settings and return to the [Dual Rate] screen.)

2 Enable the curve: switch SA hits the 2nd gear activation curve, and the curve activation indicates that the arrow moves to the position number 2 (above).

3 Edit curve: The up and down keys switch to the curve setting interface on the second page to adjust the curve (as shown below), and the curve associated with the adjusted SA is set.

4 Press the Back button to return to the [General Menu] menu and save the settings.

When the curve is set, the switch associated with other number needs to be deactivated, otherwise the set curve will be the highest priority number curve that is activated.

Rate: The amount of rudder angle can be adjusted for rudder angle.

EXP: Exponential curve, setting of the action curve. When the negative value is near the neutral, it is slow, and when it is positive, it is close to the parameter near the neutral.

Rate: The action curve point position can be moved up and down.

The Confirm key switch point and the left and right keys to adjust the value.

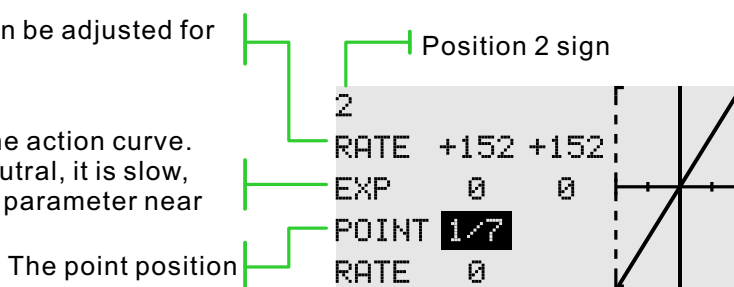



# GENERAL MENU

## END POINT

Interface path: GOME/MON. → [GENERAL MENU] → [END POINT]

This function can adjust the end point on the left and right sides of the servo respectively, for correction on the machine body connection.

The end point on the left and right sides can be 30%-155% (CH1-CH6), and the default value is 100%. The maximum end point limit can be set between 0% and 155% with a default value of 135%.

After setting this limit point, even if the operation such as mixing control increases the steering stroke amount, the action of the servo will not exceed the limit point, thus locking the servo and protecting the connection.

The actual rotation of each channel servo is displayed on the interface. The display of the neutral position is based on the setting value of "Sub Trim". Therefore, the adjustment of "Sub Trim" will affect the upper and lower limit points of the servo position.

END POINT		1/6	
	TRAVEL	TRAVEL	
1 AIL	100%	100%	
2 ELE	100%	100%	
3 THR	100%	100%	

Left travel
Right travel

Left limit
Right limit

Action Direction

END POINT		3/6	
	LIMIT	LIMIT	
1 AIL	135%	135%	
2 ELE	135%	135%	
3 THR	135%	135%	

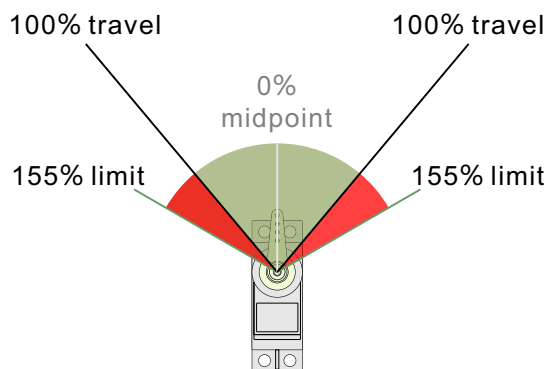

Example of operation (upper right picture shows maximum limit and default travel):

1 As shown in the chart above, the left limit of the throttle has been set to 90%. The throttle stick we hit the maximum position, as shown below. Although the stroke is still 100%, the maximum limit (red line position) output is limited to 90%.

2 The left limit of the throttle is still 90%, and the stroke is changed to 50%. The throttle stick we hit the maximum position, as shown below. Although the limit is 90%, the throttle's output travel is limited to 50%, so the output maximum position can only reach half of the normal travel (red line mark)

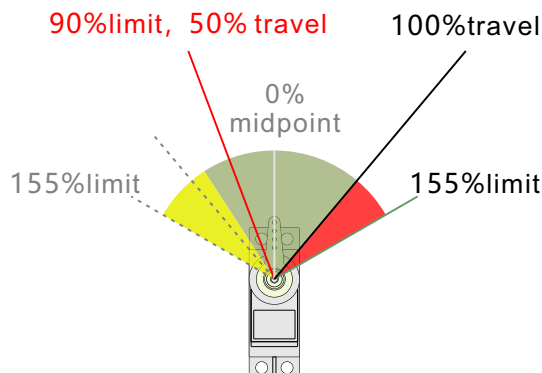
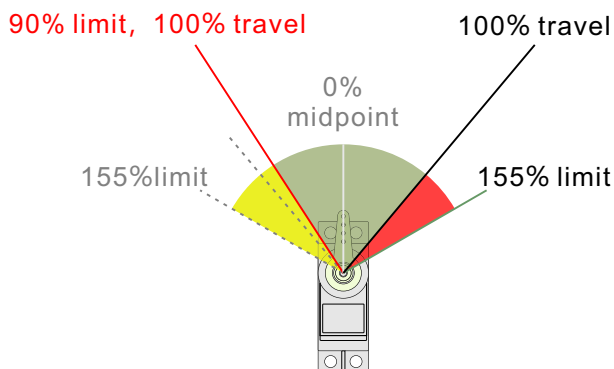

## TIMER

Interface path: HOME/MON.→ [GENERAL MENU] → [TIMER]

This timer function can be used for a variety of timings such as the total flight duration and the specific time of the game. Timer 1 and Timer 2 can be set and displayed on the main standby screen.

The timer is an independent function in each model. When the model is changed, the timer corresponding to the new model will be automatically recalled.

The timer can be started or stopped by operations such as switches or ticks. And the direction of the start and stop switches can be set automatically. Positive timing and countdown can be set to a maximum of 99 minutes and 59 seconds.

UP: starting from 0, increasing with time  
Down: decrease from the set time

INH, turn off the power or replace the new model and reset the timer to zero clearing.  
ACT, Memory of the previous timing data while rebooting.

```

TIMER 1  00:00.0  1/3
ALARM    15:00
MODE     UP      ELAPSED
MEMORY   INH     START  --
RESET    --      STOP   █
            
```

Interface page

Minute:0-99;Seconds:0-59

**Timed completion:** according to the set time prompt.

**Remaining time:**reminder once every 1 minute the remaining time of the distance alarm reduced every 1 minute.

**Reminder every minute:** ring for 1 minute.

Reset, start, close, it can be operated by switches and the like.

**Case Setting (timer 1 15 minutes countdown, ringing alarm, open vibration, switch SA control):**

1 Time setting, as shown on the right, warning bar, the left minute value is adjusted to "15", and the right side is set to "Remaining time".

2 Mode setting, mode is set to "countdown".

3 Vibration setting, vibration is set to "Vibration 1".

4 Memory setting, open as needed, keep the default here.

5 Switch setting, the start switch is set to "SA/2 gear", the stop switch is set to "SA/1 gear", and the reset switch is set to "SA/0 gear". (So we can control the timer 1 with just one switch). After the activation and activation effect: the timing starts, the reminder becomes a continuous "tick-tick-tick..." sound when the remaining 20 seconds, and the reminder becomes continuous "ticktick-ticktick-tick" when 10 seconds left. The sound of "tick...", at the end of the countdown, there will be a long beep with the vibration of the type "Vibration 1"; then the timing will continue and show a negative value.

```

TIMER 1  00:00.0  1/3
ALARM    15:00
MODE     DOWN    REMAINDE
MEMORY   INH     START  SA
RESET    SA      STOP   SA
            
```

Model time:the accumulated time of model working,the account unit is hour-miunte-second.

Control mode:boot timer, or switch/stick(such as throttle stick)

```

MODEL TIMER  10:12.6
MODE         POWER ON
            
```

## TRIM SETTING

Interface path: HOME/MON. → [GENERAL MENU] → [TRIM SETTING].

In this function, you can set the amount of digital trim and the action mode, and you can select the trim step movement under each condition, or trim the individual movement under each condition. (For example, hover and stunt can be trimmed separately.)

Step: Adjustable travel 1-250, the default step value is 40 (the amount of motion change per trimming).

### T1-T4:

Link: For example, after T1 is linked, the channel assigned by the corresponding T1 will follow the action.

Switch: INH, 2 POS, 3 POS, the default "INH", control the corresponding trimming dynamic display of the main interface. Inhibit, the main interface hides the corresponding trim switch. 2, 3 POS, the main interface display corresponding trimming switch

Condition: Group, single, default "group". Group modes: The same trimming data is reflected in all flight conditions. Single mode: Individual trimming adjustments are possible under each condition.

	STEP	LINK	SW	CONDI.
T1	40	OFF	INH	ALL
T2	40	OFF	INH	ALL
T3	40	OFF	INH	ALL
T4	40	OFF	INH	ALL

## SUB-TRIM

Interface path: HOME/MON. → [GENERAL MENU] → [SUB-TRIM]

This function is a function to trim the neutral position of each servo. In addition, the neutrality of the rudder surface can be trimmed while the connecting rod is connected.

When starting the [Sub-trim] setting, you must firstly sub trim each channel (checked by the monitor) to the center position.

Before adjusting [Sub-trim], be sure to adjust the control surface (servo)control link on the model firstly, and then use the [Sub-trim] function.

	SUB-TRIM	1/2
1 AIL	0	
2 ELE	0	
3 THR	0	
4 DIR	0	

Trave: -240~+240

## CHANNEL DELAY

Interface path: HOME/MON. → [GENERAL MENU] → [CHANNEL DELAY]

This function is mainly used for realistic actions, such as retracting the undercarriage (reducing the response speed of the output channel), setting the stroke to 0 to 100, and the default is 0 (corresponding to the delay time of the channel stick position from one end to the other end is the set time).

The larger the value displayed on the interface, the larger the delay and the slower the output of the action.

CHANNEL DELAY 1/3	
STATUS	INH
SWITCH	--
1 AIL	0
2 ELE	0

- Customize any switch, knob, etc.  
Used to enable and disable the delay function
- Default "0", no delay  
Maximum value "100", Maximum delay

## PROGRAM MIXES

Interface path: HOME/MON. → [GENERAL MENU] → [PROGRAM MIXES]

It can create 5 mixing combinations, which can be customized by selecting channels or switch knobs, in addition to being used to create a variety of aircraft flight characteristics, it can be used for a variety of other purposes.

The direction of the mixing ratio can be set separately.

Ratio mode: Ratio mixing for simple mixing with directional settings.

Curve mode: Curve mixing, precise control of mixing between different strokes, where “polyline” can be precisely adjusted using 7 points.

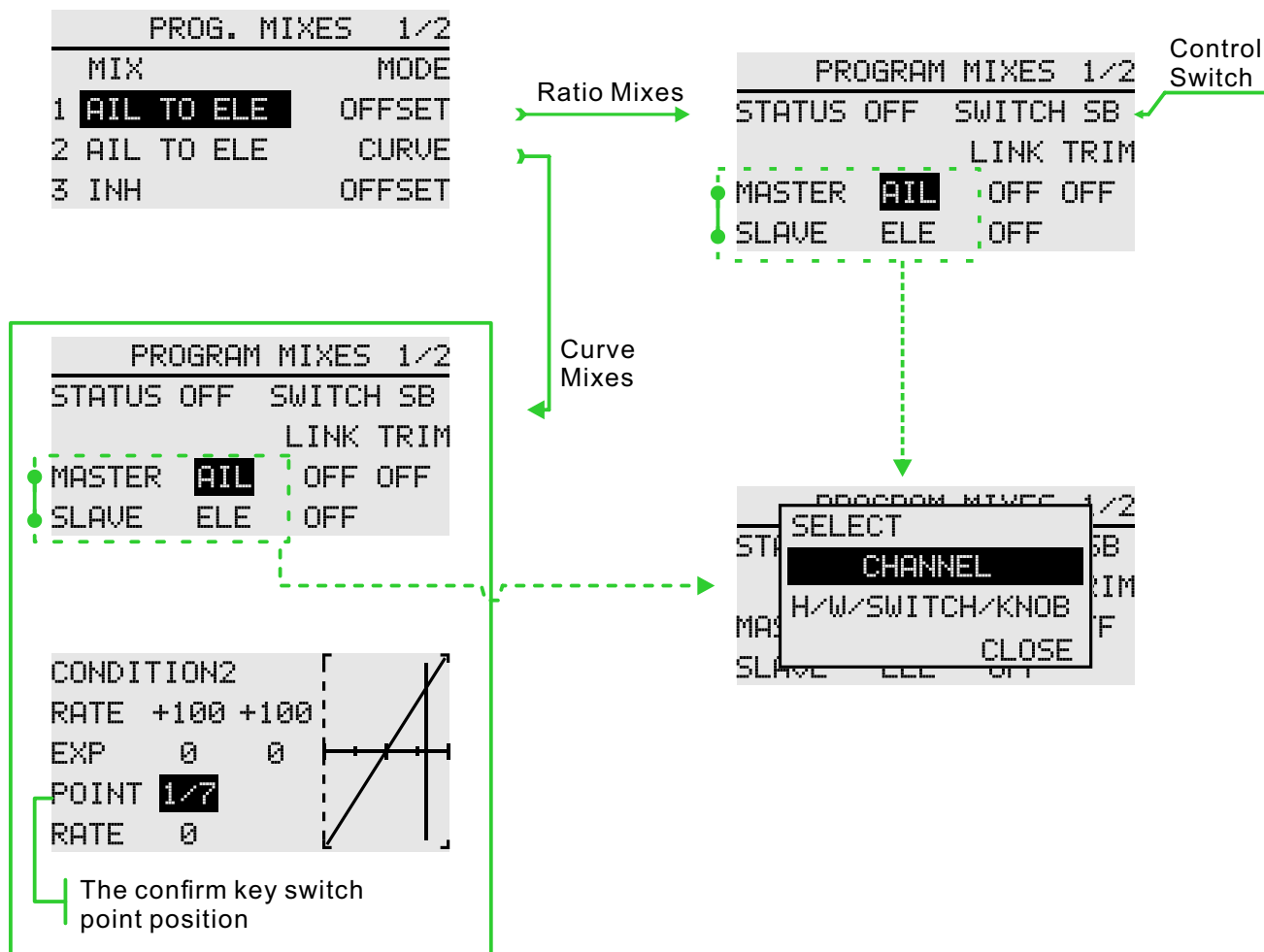

### The setting of the ratio programming mixes (refer to the above mixing 1/2):

1 Switch the mode to the ratio and click on the name of the mixed control 1 (the mixed control name is the name generated by the combination of the primary and secondary channels, such as the view from the throttle to the aileron), and enter the mixing configuration interface.

2 To use this programming mixes, you need to enable this feature, so the status needs to be switched to enabled. (When inhibit, the control switch cannot be activated when it hits the active position.)

3 Set the control switch, the default is [--], we can set it as switch, knob rocker and so on.

4 Assign the primary and secondary channels, and confirm the channel polarity by actual operation

### (refer to the above mixing 2/2) rate mode:

- Set the mixing ratio. There are two ratios of positive and negative, which can control the mixing ratio in both directions
- Set the offset ratio, which is used to set the up and down offset of the midpoint of the overall mixing position relationship.

### (refer to the above mixing 2/2) curve mode:

- Set the mixing control rate and adjust the positions of both sides of the curve.
- Set EXP and adjust the bending rate and direction on both sides of the line.
- Set the point. The dotted line in the curve box on the right is the position of the current point. Change the rate to adjust the upper and lower offset.

# GENERAL MENU

## FLIGHT MODE

Interface path: HOME/MON. → [GENERAL MENU] → [FLIGHT MODE]

This function can be combined by two arbitrary switches or knobs, rockers, etc. to form up to 9 different ratios of output. Each output user can set it according to actual needs, which is suitable for some flight control boards for various flight conditions. Demand for use.

For details, please refer to the instruction manual of the flight control board, and set the most reasonable operation mode according to the user's own usage habits.

The arrow indicates where the effect is

		FLIGHT MODE
Function Status	INH	▶1.1100
Control Switch 1	--	2.1250
Control Switch 2	--	3.1400
		4.1550

---

### Mode Description:

There are at least 4 mode outputs (2 positions switch x 2 positions switch = four states).

There are up to 9 mode outputs (3 positions switch x 3 positions switch = 9 states).

The arrow position is the active position of the current switch gear combination and does not affect the setting parameters.

### WARNING

Please verify the setting result after setting. Please remove the blade when is commissioning verification, be careful to avoid injury by the model.

## DOUBLE ENGINE

Interface path: HOME/MON. → [GENERAL MENU] → [DOUBLE ENGINE]

The output channels of Engine 1 and Engine 2 need to be set in the [General Menu] - [Function] menu.

When part of the model aircraft, ship model, and car model use two motors as the power drive, the dual engine function can be directly used, and the engine 1, the acceleration rocker and the steering stick of the engine 2, and the engine 1 and the engine 2 can be simply set. Mixing rate. In the robot model and the ship model, the bidirectional electronic governor ratio setting is supported, and the control direction can be quickly switched by setting a forward and reverse switch. Double engine function supports 3 rate settings, each rate supports separate control switches.

STATUS	<b>INH</b>	1/4	Function status button (INH, ACT, default [INH])
MODE	RUNIDIR		Unidir: One-way electronic governor such as empty mode (acceleration only supports setting forward) Bidir: Two-way electronic governor for ship model, car model, robot, etc. (Acceleration support settings forward and backward)
SWITCH	1 2 3		Switch: Supports 3 ratios and control switch settings. The priority ratio 3 is the highest
RATE	50% 25%		Rate: Equivalent to dual rate, supports switching of 3 different ratios.

THR H/W	<b>--</b>	2/4	Accelerate stick: Control engine 1 and engine 2 rotate at the same speed to achieve forward or backward
REVERSE	--	NOR	Positive and negative: Set the control switch for controlling the positive/negative
FORWARD	+100% +100%		Forward: set the forward rate

RUD H/W	<b>--</b>	3/4	Direction stick: Control engine 1, engine 2 rotates at a differential speed, Implement left or right turn.
REVERSE	--	NOR	Positive and negative: Set the control switch for controlling the positive/negative
RUD(L)	+50% +100%		Direction (left): Set the ratio of the left turn
RUD(R)	+100% +50%		Direction (right): Set the ratio of right turn

ENG HOLD		4/4	
STATUS	<b>INH</b>		Engine hold working status
SWITCH	--		Hold function control switch assignment
ENG1	-152%		
ENG2	-152%		Throttle hold position

### The output of the default parameter

#### Accelerate stick

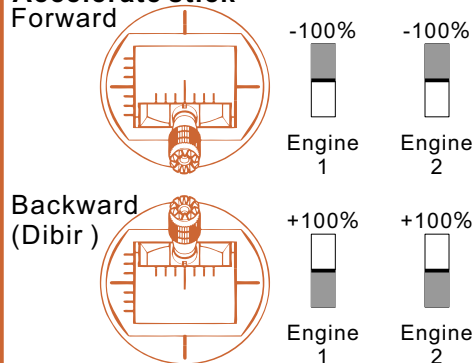

#### Direction stick (Single way)

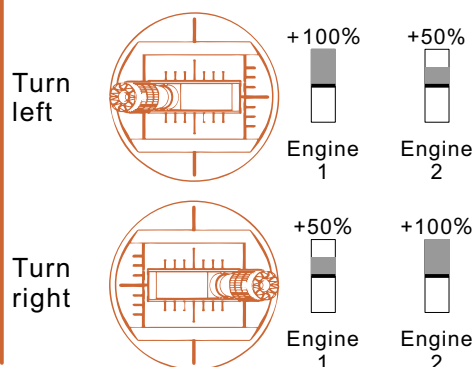

#### Direction stick (Two way)

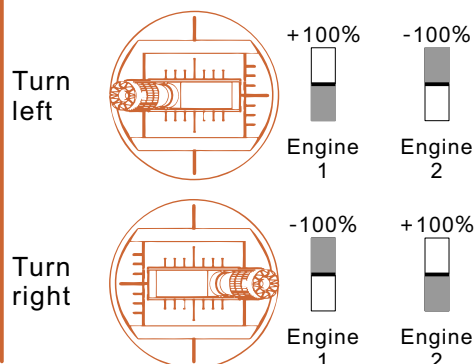



## CONDITION

Interface path: HOME/MON. → [MODEL MENU] → [CONDITION]

With this function, flight conditions can be configured as needed, and there are 3 flight conditions to choose from.

If you do not need to use the conditional switching function, you do not have to set it on this page. The default configuration can be used directly.

When multiple flight conditions are set, the priority between them is to prioritize the final flight conditions!

Delay: Avoid swaying of the fuselage caused by sudden changes in the position of the servo or the unsynchronized action time between the passages when switching flight conditions.

Effective mode indication

CONDITION	
▶ NORMAL	
IDLE	--
HOLD	--
DELAY	

Assign control switch: By default, there is no switch assignment (--), click to enter the assignment interface. Switching between flight conditions can be performed using switches such as a toggle switch, a stick, and a side lever. Set the unwanted flight condition switch to empty (--)

Delay configuration interface point

Current fly mode

NORMAL		1/2
1 AIL	0	
2 ELE	0	
3 THR	0	
4 RUD	0	

\* The corresponding delay can be set separately for each fly mode. By activating the control switch set, the delay value of each channel corresponding to the flight mode can be set.

## THROTTLE CURVE

Interface path: HOME/MON. → [MODEL MENU] → [THROTTLE CURVE]

EXP+7 point broken line, adjust the throttle output curve according to the throttle stick action, so that the engine (motor) revolution reaches the optimal flight state.

**WARNING** When starting the engine, be sure to start the engine at normal idle speed in normal mode.

"Fly mode" controls the pitch curve, and different modes are enabled for curve adjustment when setting.

Adjust the rate of output value of left and right curves respectively.

EXP fuses 7-point polyline mode.

Adjust the upper and lower offset of the selected curve reference point, and switch the reference point by confirming key (long press to reset value).

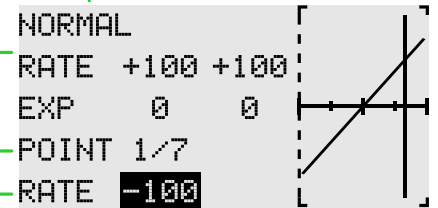

### Curve setting example

\* Flight conditions: Set the "Flight Condition" control switch in [Model Menu] → [Condition]. Switching by the switch, the function curve setting is performed separately.

The following curves are made in the default polyline adjustment. When the curve is actually set, it is input according to the specified (or reference value) action amount of the model.

- Adjustment of the standard curve: The standard curve is a basic curve set with hovering as the center. With the pitch curve (standard), the number of engine revolutions is fixed, and the up and down control is the easiest.

- Adjustment of the stunt curve: The stunt curve is used to keep the engine at a certain speed even if the pitch is reduced during high altitude flight. For the purpose of movements such as tendons, roll, and 3D, special effects curves are sometimes used depending on the stunt action.

Standard Curve

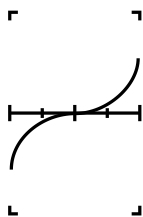

Idle Curve 1

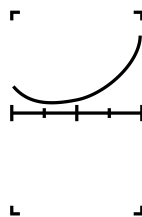

Idle Curve 2

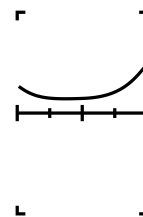

## PITCH CURVE

Interface path: HOME/MON. → [MODEL MENU] → [PITCH CURVE]

This function adjusts the pitch curve for each "fly condition" to get the best flight status following the throttle stick action.

**WARNING** Start the engine. be sure to turn off the "idle" function switch and start the engine at idle down when flying.

"Fly Mode" controls the pitch curve, and different modes are enabled for curve adjustment when setting.

Adjust the rate of output value of left and right curves respectively.

There are seven reference points

Adjust the selected curve reference point up and down offset, confirm the key switch reference point (long press to reset value).

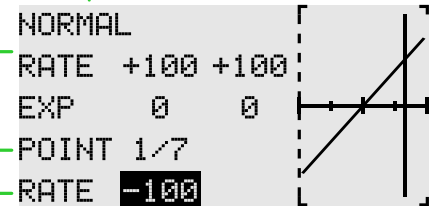

\* Flight mode: set "Fly Mode" control switch in "model function" → "Flight Mode". Switch through the switch, respectively for function curve setting.

### Curve setting example

The following curves are made in the default polyline adjustment. When the curve is actually set, it is input according to the specified (or reference value) action amount of the model.

Adjustment of the standard curve: Polyline is usually used. The standard curve is a basic curve set around the hover. With the throttle curve (standard), the number of engine revolutions is fixed, making the up and down control the easiest

Adjustment of the idle curve: The high pitch curve sets the maximum pitch that is not burdened by the engine. The low pitch curve is set for the purpose of matching the movement of the ribs, the roll, and the 3D. The idle curve is sometimes used depending on the stunt action.

Adjustment of the throttle lock curve: The throttle hold curve is used for the descent landing process.

Standard curve

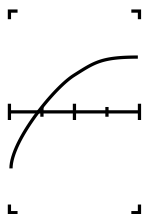

Idle curve 1

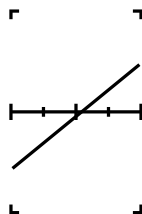

Idle curve 2

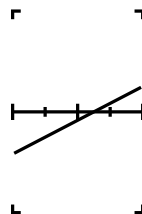

Throttle hold curve

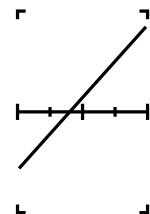

## THROTTLE HOLD

Interface path: HOME/MON. → [MODEL MENU] → [THROTTLE HOLD]

Mainly used in model debugging. Control the throttle at the lowest position through the switch to ensure the safety of debugging.

Function control switch,  
default [--]

Range 0%-50%, default 17%

Put the stick on the throttle  
position you want to hold,  
press the left and right keys to  
adjust the value, or press the  
confirm key to get the throttle  
position when the value is  
selected.

Range 0-100, default 0  
setting response speed of  
function switch of [Throttle  
hold], no conflict with the delay  
of [Condition].

THROTTLE HOLD	
STATUS	INH
SWITH	--
HOLD POS.	17%
SPEED	0



The set throttle hold output position

Throttle current position, when  
unlocked, the throttle channel can be  
changed with the action. After locked,  
fix it in the set lock position.

## THROTTLE CUT

Interface path: HOME/MON. → [MODEL MENU] → [THROTTLE CUT]

Safely and easily to turn off the engine. Throttle cut provides an easy way to stop the engine from running. Generally speaking, it can be realized by dialing a hardware switch in an idle state. This function cannot be triggered when the throttle is high to prevent any mis-operation. The position and direction of the switch must be selected because the initial setting is [--].

The selected hardware cut switch adjusts the ratio value when the throttle and throttle lever are idle down, until the engine can be completely shut down.

In addition, verify that the throttle link is not tightened or that the servo is not overloaded.

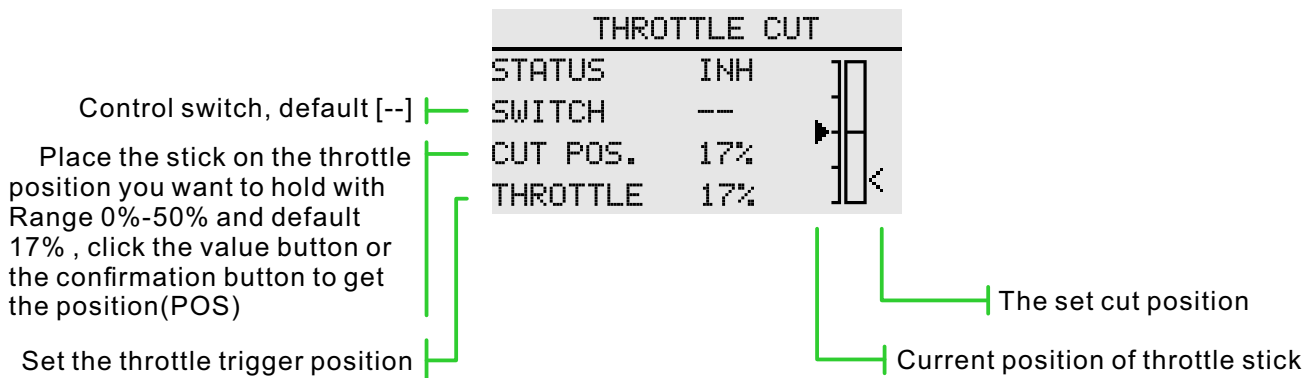

Cut position setting

- 1 Status is switched to "ACT"
- 2 Click the "Switch" button to pop up the "Switch Assignment" interface and select the control switch.
- 3 Turn on the selected "cut control switch", the engine stick is in the idle down state, adjust the rate until the engine (motor) stops completely.

Please pay attention to the throttle connection here, do not let the servo exceed the travel.

**DANGER**

The "cut position" must not be set higher than the lowest speed throttle position. It is dangerous if the engine runs at high speed.

## GYRO

Interface path: HOME/MON. → [MODEL MENU] → [GYRO]

This function is used to adjust the gyroscope sensitivity. Set the sensitivity and mode of operation (normal/AVCS) for each flight condition or switch.

Condition mode	
MODE	CONDITION
POSITION	NORMAL
STATUS	ON
TYPE	AVCS

The control gyro sensitivity can be activated by "Fly Condition" or by assigning switches, knobs, and so on.

3 modes can set the sensitivity separately

Switch mode	
MODE	SWITCH
POSITION	1
SWITCH	--
STATUS	ON

Each control switch may be provided gyro respectively, three kinds of sensitivity can be provided.

A switch, knob, etc. can be set to activate the sensitivity value of the specified position of the switch.

Disable and enable the current Gyro configuration group.

2/2	
TYPE	AVCS
RATE	AVCS100%
TUNING	--
	0% [0%]

Normal mode, (AVCS) locktail mode.

Gyro operation mode. Normal, AVCS100%

Set the associated tuning control switch, knob, etc. for sensitivity adjustment

Control switch current real-time position

Can set the trim range value  $\pm 20\%$

### Function setting

1 When using the function, first assign the function channel on the [Function] interface, and set the "Switch" and "Trim" to [--] in [Function].

2 Mode selecting. Optional "switch" or "Fly condition".

3 Position selecting. In each mode, there are 3 groups of positions to choose from, and the corresponding sensitivity can be set separately. In the "switch" mode, you need to select the position switch, the default is [--].

4 Status selecting. Select whether the "Position" configuration above is enabled or not.

5 Type selecting. Select the sensitivity type of the corresponding work for the current "position".

6 Ratio adjustment. The options vary depending on the type option ("Normal" type, "Rate" range 0%-100%; under "AVCS" type, "Rate" range is Normal[0~100%], AVCS[0~100%]).

7 Trim the switch selection and trim the ratio setting. Sensitivity tuning switch, the default is [--]; the rate value can be set to  $\pm 20\%$ . Used for trimming the sensitivity.

The sensitivity required for different flight modes is different, so switch the conditions (Position) separately for sensitivity adjustment.

## GOVERNOR

Interface path: HOME/MON. → [MODEL MENU] → [GOVERNOR]

This function is used to switch the speed of the helicopter rotor head. The helicopter head speed can be switched by a hardware switch for each flight condition.

GOVERNOR 1/2	
MODE	CONDITION
POSITION	NORMAL
STATUS	ON
RATE	50%

Condition mode

- The control governor can be activated by "Fly Condition" or by assigning switches, knobs, etc.
- The 3 "Fly Mode" can be set governor separately
- Speed adjustment. Ordinary, 100%

GOVERNOR 1/2	
MODE	SWITCH
POSITION	1
STATUS	OFF
SWITCH	--

Switch mode

- Each control switch can be set separately for the governor, and 3 positions can be set.
- Disable and enable the current "Governor" configuration group.

GOVERNOR 2/2	
RATE	50%
TUNING	--
	0% [0%]

- Can customize the switch, knob, etc. to control the designated position of the activation switch.
- Set up the relevant tuning control switch, knob, etc.
- Real-time numerical
- Tuning set range value  $\pm 20\%$ .

### Function

- 1 When using the function, firstly assign the function channel on the [Function] interface, and set the "Switch" and "tuning" to [--] in [Function].
- 2 Mode selection. Optional "switch" or "Flight Condition" mode.
- 3 Location selection. In each mode, there are 3 groups of positions to choose from, and the speed (rate) under the models can be set separately. In the switch mode, you need to select the position switch, the default is [--].
- 4 Status selection. Select whether the "Position" configuration above is enabled or not.
- 5 Ratio adjustment. Change the ratio and adjust the speed.
- 6 Tuning the switch selection and trimming the rate setting. Sensitivity tuning switch, the default is [--]; the rate value can be set to  $\pm 20\%$ . Used to tuning the speed. (When the tuning switch is [--], the preset tuning ratio speed correction is performed by default.)

## SWASH

Interface path: HOME/MON. → [MODEL MENU] → [SWASH]

Connecting rod correction function of swash (except for H-1 mode of swash)

Swash travel: function to adjust the movement of aileron, elevator, and pitch.(can be reduced/increased/reversed)

SWASH		
AILERON	+50%	← Range ±100%, Default 50%
ELEVATOR	+50%	← Range ±100%, Default 50%
PITCH	+50%	← Range ±100%, Default 50%

### Neutral point setting process (reference point for setting correction function)

1 Adjust the servo rocker arm to make the neutral point in the 50% range, in order to make the mixed control value as small as possible.

1 Move the cursor to the "midpoint position" and click to get (no key setting is supported) to read the position of the throttle rocker (the neutral point value of the steering gear).After reading the neutral point value, use other correction functions for subsequent Settings.

### Steps for setting mixed control rate

\* Take HR3 as an example to describe the setting process of mixed control rate.

- Set the throttle stick to a preset neutral position.Adjust the length of the connecting rod so that the cross disc remains level at this point.

- Trim function to make small adjustments.

- Adjust the pitch curve in a straight line and make the helicopter pitch reach the maximum value.

- Adjust the ratio data to be corrected

1. Adjust the aileron operation

Adjust the aileron stick to move left and right so that the collective or pitch direction does not interfere.

2. Adjust the operation of elevator

Adjust the elevator rocker up and down so that the aileron or pitch direction is not disturbed.

\* Adjust the ratio so that when the throttle lever is idle and full, make sure the swash is only moving horizontally.



## CONDITION

Interface path: HOME/MON. → [MODEL MENU] → [CONDITION]

With this function, flight conditions can be configured as needed, and there are 3 flight conditions to choose from.

If you do not need to use the conditional switching function, you do not have to set it on this page. The default configuration can be used directly.

When multiple flight conditions are set, the priority between them is to prioritize the final flight conditions!

Delay: Avoid swaying of the fuselage caused by sudden changes in the position of the servo or the unsynchronized action time between the passages when switching flight conditions.

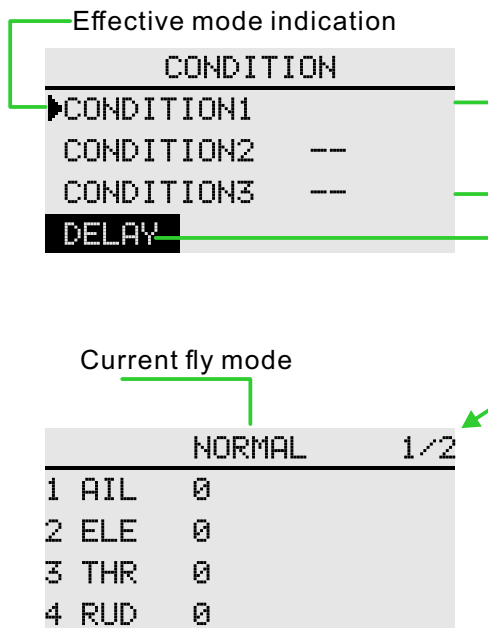

Assign control switch: By default, there is no switch assignment (--), click to enter the assignment interface. Switching between flight conditions can be performed using switches such as a toggle switch, a stick, and a side lever. Set the unwanted flight condition switch to empty (--)

Delay configuration interface point

\* The corresponding delay can be set separately for each fly mode. By activating the control switch set, the delay value of each channel corresponding to the flight mode can be set.

## AIL DIFF

Interface path: HOME/MON. → [MODEL MENU] → [AIL DIFF]

When the ailerons are controlled by two servos, the ratio of the upper and lower rudder angles of the left and right ailerons can be independently adjusted.

\*This function is only used on the two-wing models after the model is selected.

AIL DIFF		
	AIL	AIL2
LEFT	+100%	+100%
RIGHT	+100%	+100%

Range 0-120%, default 100%

Set end point of each servo

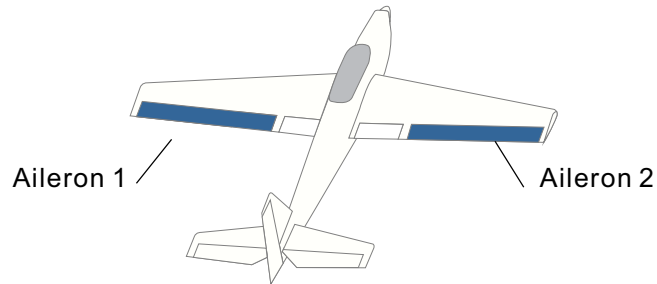

---

\* When debugging, please operate the stick to the end point for maximum motion verification to avoid exceeding the range of the servo or the body.

## THROTTLE CURVE

Interface path: HOME/MON. → [MODEL MENU] → [THROTTLE CURVE]

This function adjusts the action curve of throttle channel to optimize the power of throttle stick input.

**WARNING** When starting the engine, be sure to start it in normal mode at a normal idle speed.

Condition controls the pitch curve, and different modes are enabled for curve adjustment when setting.

Adjust the ratio of output value of left and right curves respectively.

Adjust the center point of the curve to move up and down.

There're 7 curve reference points

Adjust the overall offset of the selected curve reference point, and press ok to switch the reference point (long press to reset value).

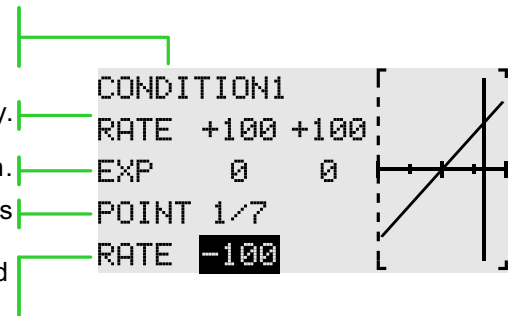

### Set instructions

The curve control switch of throttle hold should be set in [MODEL MENU] → THROTTLE GOLD].

Note: Start the engine in normal mode at normal idle.

\* Fly mode: set "Fly Mode" control switch in "Model Menu" → "Condition". Switch through the switch, respectively for function setting.

## THROTTLE HOLD

Interface path:HOME/MON.→ [MODEL MENU]→[THROTTLE HOLD]

Mainly used in model debugging.Control the throttle at the lowest position through the switch to ensure the safety of debugging.

Function control, default [--]

Range 0%-50%, default 17%,click the value button or the confirmation button to get the position(POS.).

Range 0-100, default 0 setting response speed of function switch of [Throttle Hold], no conflict with the delay of [Fly Mode].

THROTTLE HOLD	
STATUS	INH
SWITCH	--
HOLD POS.	17%
SPEED	0



The set throttle hold position

Current position of throttle stick

## THROTTLE CUT

Interface path: HOME/MON.→ [MODEL MENU]→[THROTTLE CUT]

Safely and easily to turn off the engine. Throttle cut provides an easy way to stop the engine from running. Generally speaking, it can be realized by dialing a hardware switch in an idle state. This function cannot be triggered when the throttle is high to prevent any misoperation. The position and direction of the switch must be selected because the initial setting is [--].

\* When both [Throttle Hold] and [Throttle Cut] are enabled, the function of [Throttle Hold] has the highest priority.

The selected hardware cut switch adjusts the ratio value when the throttle and throttle lever are idle down, until the engine can be completely shut down.

In addition, verify that the throttle link is not tightened or that the servo is not overloaded.

THROTTLE CUT	
STATUS	INH
SWITCH	--
CUT POS.	17%
THROTTLE	17%

Function control, default [--]

Range 0%-50%, default 17%  
Press the left and right keys to adjust the value or press the ok key to intercept the position parameters of the STICK.

Set the throttle trigger position

The set cut position

Current position of throttle stick

### Cut position setting

- 1 Status is switched to "ACT"
- 2 Click the "Switch" button to pop up the "Switch Assignment" interface and select the control switch.
- 3 Turn on the selected "cut control switch", the engine stick is in the idle down state, adjust the rate until the engine (motor) stops completely.  
Please pay attention to the throttle connection here, do not let the servo exceed the travel.

\* Fly Mode: set "Fly Mode" control switch in "Model Menu" → "Fly Condition". Switch through the switch, respectively for function setting.

**DANGER** The "cut position" must not be set higher than the lowest speed of throttle position. It is dangerous if the engine runs at high speed.

## GYRO

Interface path: HOME/MON. → [MODEL MENU] → [GYRO]

This function is used to adjust the gyroscope sensitivity. Set the sensitivity and mode of operation (normal/AVCS) for each flight condition or switch.

Condition mode		GYRO 1/2
MODE	CONDITION	
POSITION	NORMAL	
STATUS	ON	
TYPE	AVCS	

The control gyro sensitivity can be activated by "Fly Condition" or by assigning switches, knobs, and so on.

3 modes can set the sensitivity separately

Switch mode		GYRO 1/2
MODE	SWITCH	
POSITION	1	
SWITCH	--	
STATUS	ON	

Each control switch may be provided gyro respectively, three kinds of sensitivity can be provided.

A switch, knob, etc. can be set to activate the sensitivity value of the specified position of the switch.

Disable and enable the current Gyro configuration group.

		GYRO 2/2
TYPE	AVCS	
RATE	AVCS100%	
TUNING	--	
	0% [0%]	

Normal mode, (AVCS) locktail mode.

Gyro operation mode. Normal, AVCS100%

Set the associated tuning control switch, knob, etc. for sensitivity adjustment

Control switch current real-time position

Can set the trim range value  $\pm 20\%$

### Function setting

1 When using the function, first assign the function channel on the [Function] interface, and set the "Switch" and "Trim" to [--] in [Function].

2 Mode selecting. Optional "switch" or "Fly condition".

3 Position selecting. In each mode, there are 3 groups of positions to choose from, and the corresponding sensitivity can be set separately. In the "switch" mode, you need to select the position switch, the default is [--].

4 Status selecting. Select whether the "Position" configuration above is enabled or not.

5 Type selecting. Select the sensitivity type of the corresponding work for the current "position".

6 Ratio adjustment. The options vary depending on the type option ("Normal" type, "Rate" range 0%-100%; under "AVCS" type, "Rate" range is Normal[0~100%], AVCS[0~100%]).

7 Trim the switch selection and trim the ratio setting. Sensitivity tuning switch, the default is [--]; the rate value can be set to  $\pm 20\%$ . Used for trimming the sensitivity.

The sensitivity required for different flight modes is different, so switch the conditions (Position) separately for sensitivity adjustment.

## AIRBRAKE

Interface path: HOME/MON. → [MODEL MENU] → [AIRBRAKE]

This function is used to increase the resistance of the model when diving or landing.

The preset elevator and flap offset values can be activated via the control switch. The offset rates of the ailerons, elevators, and flap servos can be adjusted as needed. It is also possible to adjust the speed of the ailerons, elevators and flap servos.

Function status button (INH, ON, default [INH])	└─	AIRBRAKE	1/2
Function action switch (default [--])	└─	STATUS	INH
		SWITCH	--
Each channel can be individually set to delay	┌─	AIL DELAY	0
		ELE DELAY	0
		AIRBRAKE	2/2
Offset direction adjustment, Range ±250%, default 0%	┌─	AIL	0%
		AIL2	0%
		ELE	0%
		ELE2	0%

\*Different combinations of different models

-----  
Example of F3A and other flap type settings (model type with 2 ailerons selected):

Status: [ACT]

Switch: [SC], off - on - off. (Assignment according to your own operating habits)

Delay: Make the transition of the action more natural

Offset: Aileron: [-35~-45%]

Aileron 2: [-35~-45%]

Elevator: [+5~7%]

Notice: The values entered here are only examples. Please adjust the servo stroke according to the actual debugging effect of the model

## EIE TO CAMBER

Interface path: HOME/MON. → [MODEL MENU] → [ELE TO CAMBER]

Use this function when you need to mix flap operation and elevator operation. When the mixing control is turned on, the elevator will be raised while the flap is lowered, which can increase the lift.

ELE TO CAMBER 1/2	
STATUS	INH
SWITCH	--

→ Function status switch (INH, ON, default [INH])

→ Control switch assignment, default [--]

ELE TO CAMBER 2/2		
	AIL	AIL2
RATE1	0%	0%
RATE2	0%	0%

] Adjust in the positive and negative directions, range ±100%, default 0%

---

This function can be switched "on" or "off" with the switch during flight. (If you want to keep it on, set it to [--], you can also set it to [--], and the position is "On" to achieve the function normally open.)

When the mixing is activated, the elevator on the tailless wing is also affected.



## WINGLET

Interface path: HOME/MON. → [MODEL MENU] → [WINGLET]

This function is used to adjust the left and right rudder of the model winglet. The winglet is used to reduce the induced drag caused by the wing tip vortex. (Winglets are vertical or angled extensions at the end of each wing.)

The winglets can significantly increase the wing's aspect ratio without increasing the structural stress and weight of the wing. Although increasing the span is also able to reduce the induced drag, it also introduces parasitic drag and requires more power to support the weight of the wing, which results in no overall savings. The winglet can help solve this problem, it increases the aspect ratio, but does not increase the wing's wingspan.

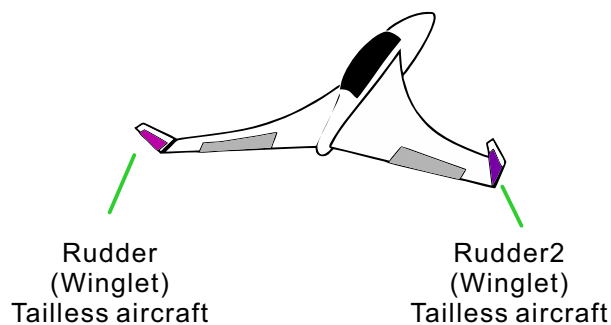

WINGLET		
	LEFT	RIGHT
RUD	0%	0%
RUD2	0%	0%

—| Function state switch (INH, ACT, default [INH])

—| Adjust the action amount of rudder respectively, the default is 100%

- 
- The amount of operation of each servo can be adjusted separately. (For the connection method of the steering gear, please refer to "Servo connection in different model categories")
  - When the connection causes the mixing direction to be reversed, it can be adjusted by changing the polarity (+/-) of the action amount.
  - When the amount of action is too large or the rudder is repeated, the servo may not respond. Be sure to confirm the actual movement of the body when setting

## ELEVATOR

Interface path: HOME/MON. → [MODEL MENU] → [ELEVATOR]

If the aileron type is selected in the model type selection function of the context menu and the aileron type is selected in the tail type, the elevator of the aileron elevator tail type can be adjusted in this setting interface. (Only for the body with one servo on each side of the elevator)

When operating the ailerons, let the elevator servo act as aileron to improve the performance of the rolling shaft.

AILEVATOR		1/2
ELE	DOWN	UP
ELE	+100%	+100%
ELE2	+100%	+100%

Range±120%,default 100%

AILEVATOR		2/2
AIL		
	LEFT	RIGHT
ELE	0%	0%
ELE2	0%	0%

Adjust the amount of action of the aileron action on the elevator. (Set to 0 if only the 2 servos of the elevator are used instead of the ailerons)

Adjust the amount of movement of the elevator separately

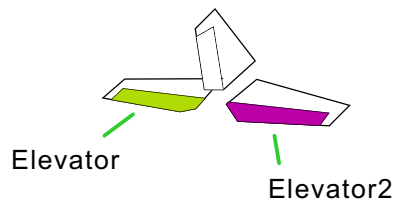

- 
- The amount of operation of each servo can be adjusted separately. (For the connection method of the servo, please refer to "Servo connection of different model categories")
  - When the connection causes the mixing direction to be reversed, it can be adjusted by changing the polarity (+/-) of the action amount.
  - If the amount of motion is too large or the rudder is repeatedly played, the servo may be unresponsive. Be sure to confirm the actual movement of the body when setting.

## V-TAIL

Interface path: WFLY → [MODEL MENU] → [V-TAIL]

If the tail type is "V-tail" which is selected from the model type selection of the context menu, the elevator and rudder of the V-tail can be adjusted in this interface. (The V-tail uses two servos to control the rudder at the same time. It is used as an elevator. In addition to the simultaneous lifting and lowering of each rudder surface (used as an elevator), the two rudder surfaces are used as rudders in the opposite direction. For the V-tail, This is also known as the direction elevator because they can be used for both the rudder and the elevator.)

Adjust the amount of the elevator

V-TAIL		1/2
ELE	DOWN	UP
ELE	+50%	+50%
RUD	+50%	+50%

Range ±120%;  
Default 50%

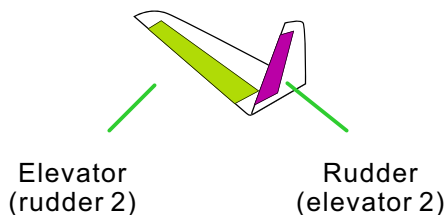

Adjust the amount of the rudder

V-TAIL		2/2
AIL	LEFT	RIGHT
ELE	+50%	+50%
RUD	+50%	+50%

Range ±120%;  
Default 50%

- The amount of operation of each servo can be adjusted separately. (For the connection method of the servo, please refer to "Servo connection of different model categories")
- When the connection causes the mixing direction to be reversed, it can be adjusted by changing the polarity (+/-) of the action amount.
- When the amount of action is too large or the rudder is repeated, the servo may not respond. Please adjust before and after 50%. Be sure to confirm the actual movement of the body when setting.

Action output example:

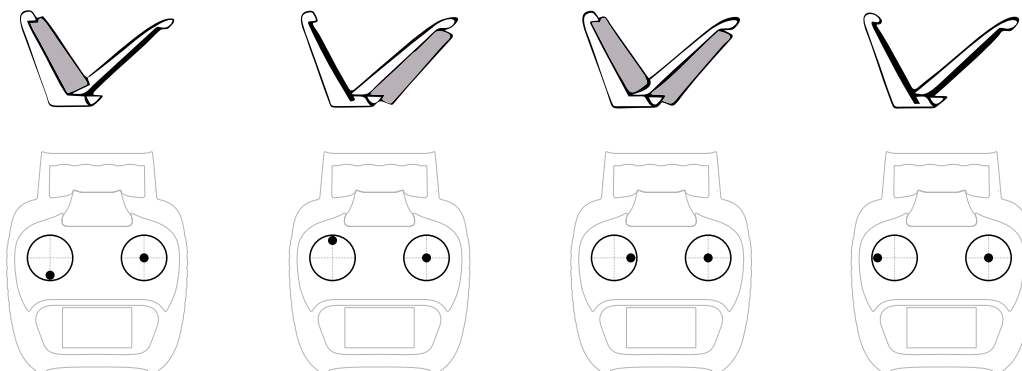

# MODEL MENU \ AIRPLANE

## FLYWIN

Interface path: HOME/MON.Y → [SYSTEM SETTING] → [MODEL TYPE] → [PLANE] → [FLYWIN]

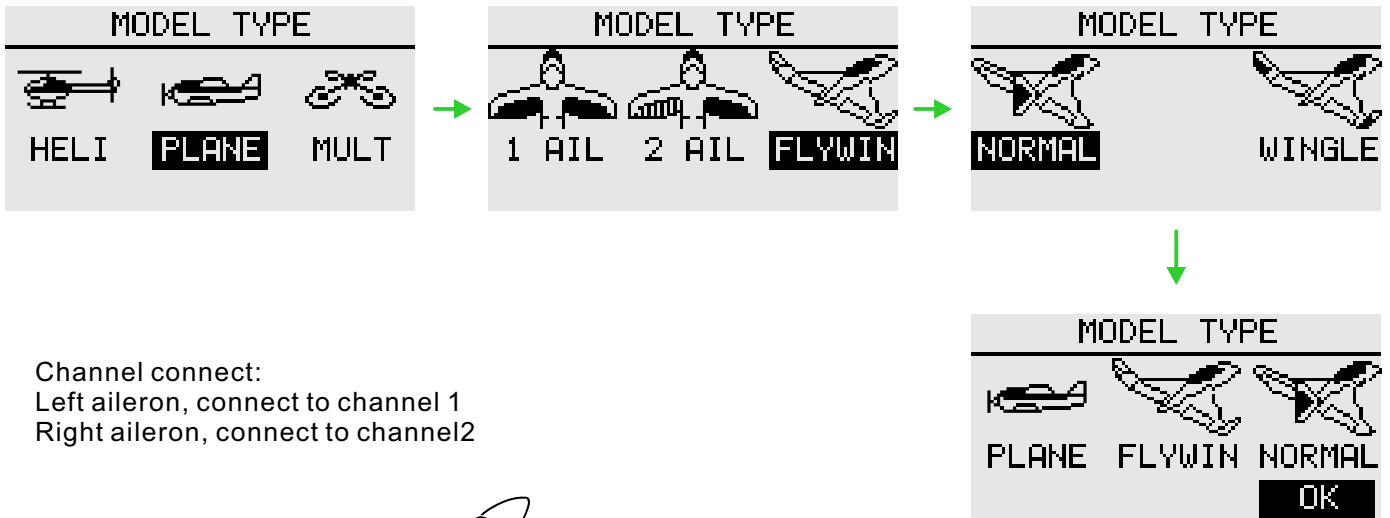

Channel connect:

Left aileron, connect to channel 1  
Right aileron, connect to channel 2

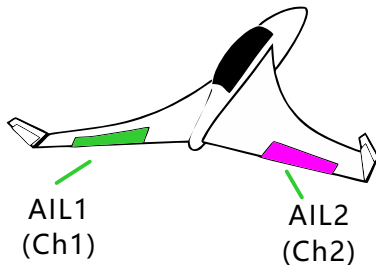

AIL1,AIL2 travel set

\*Interface: [GENERAL MENU] - [END POINT]

	END POINT 1/4	
	TRAVEL	TRAVEL
1 AIL	100%	100%
2 ELE	100%	100%
3 THR	100%	100%

	END POINT 3/4	
	LIMIT	LIMIT
1 AIL	135%	135%
2 ELE	135%	135%
3 THR	135%	135%

AIL1,AIL2, SERVO REVERSE(If the steering direction of the rudder Angle is wrong, check whether the steering gear is connected correctly, and then conduct positive and negative setting)

	SERVO REVERSE 1/2
1AIL	NOR
2ELE	NOR
3THR	REV
4RUD	NOR

## CONDITION

Interface path: HOME/MON. → [MODEL MENU] → [CONDITION]

With this function, flight conditions can be configured as needed, and there are 3 flight conditions to choose from.

If you do not need to use the conditional switching function, you do not have to set it on this page. The default configuration can be used directly.

When multiple flight conditions are set, the priority between them is to prioritize the final flight conditions!

Delay: Avoid swaying of the fuselage caused by sudden changes in the position of the servo or the unsynchronized action time between the passages when switching flight conditions.

Effective mode indication

CONDITION	
▶ NORMAL	
IDLE	--
HOLD	--
DELAY	

Assign control switch: By default, there is no switch assignment (--), click to enter the assignment interface. Switching between flight conditions can be performed using switches such as a toggle switch, a stick, and a side lever. Set the unwanted flight condition switch to empty (--)

Current fly mode

NORMAL		1/2
1 AIL	0	
2 ELE	0	
3 THR	0	
4 RUD	0	

Delay configuration interface point

\* The corresponding delay can be set separately for each fly mode. By activating the control switch set, the delay value of each channel corresponding to the flight mode can be set.

## Throttle Curve

Interface path: HOME/MON. → [MODEL MENU] → [Throttle Curve]

Adjust the throttle output curve according to the action of the throttle rocker through the seven-point curve, so that the engine (motor) revolution can reach the optimal state of flight.

**WARNING** When starting the engine, be sure to start it in normal mode at a normal idle speed.

Condition controls the pitch curve, and different modes are enabled for curve adjustment when setting.

Adjust the ratio of output value of left and right curves respectively.

Adjust the center point of the curve to move up and down.

There're 7 curve reference point

Adjust the overall offset of the selected curve reference point, and press ok to switch the reference point (long press to reset value).

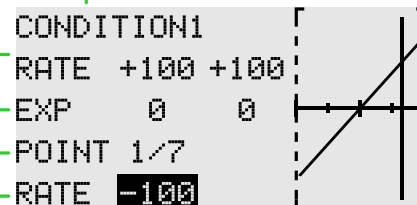

### Set instructions

The curve control switch of throttle hold should be set in [MODEL MENU] → THROTTLE GOLD].

Note: Start the engine in normal mode at normal idle.

\* Fly mode: set "Fly Mode" control switch in "Model Menu" → "Condition". Switch through the switch, respectively for function setting.

## THROTTLE HOLD

Interface path:HOME/MON.→ [MODEL MENU]→[THROTTLE HOLD]

Mainly used in model debugging. Control the throttle at the lowest position through the switch to ensure the safety of debugging.

Function control, default [--]

Range 0%-50%, default 17%,click the value button or the confirmation button to get the position(POS.).

Range 0-100, default 0 setting response speed of function switch of [Throttle Hold], no conflict with the delay of [Fly Mode].

THROTTLE HOLD	
STATUS	INH
SWITCH	--
HOLD POS.	17%
SPEED	0

The set throttle hold position

Current position of throttle stick

## THROTTLE CUT

Interface path: HOME/MON.→ [MODEL MENU]→[THROTTLE CUT]

Safely and easily to turn off the engine. Throttle cut provides an easy way to stop the engine from running. Generally speaking, it can be realized by dialing a hardware switch in an idle state. This function cannot be triggered when the throttle is high to prevent any misoperation. The position and direction of the switch must be selected because the initial setting is [--].

\* When both [Throttle Hold] and [Throttle Cut] are enabled, the function of [Throttle Hold] has the highest priority.

The selected hardware cut switch adjusts the ratio value when the throttle and throttle lever are idle down, until the engine can be completely shut down.

In addition, verify that the throttle link is not tightened or that the servo is not overloaded.

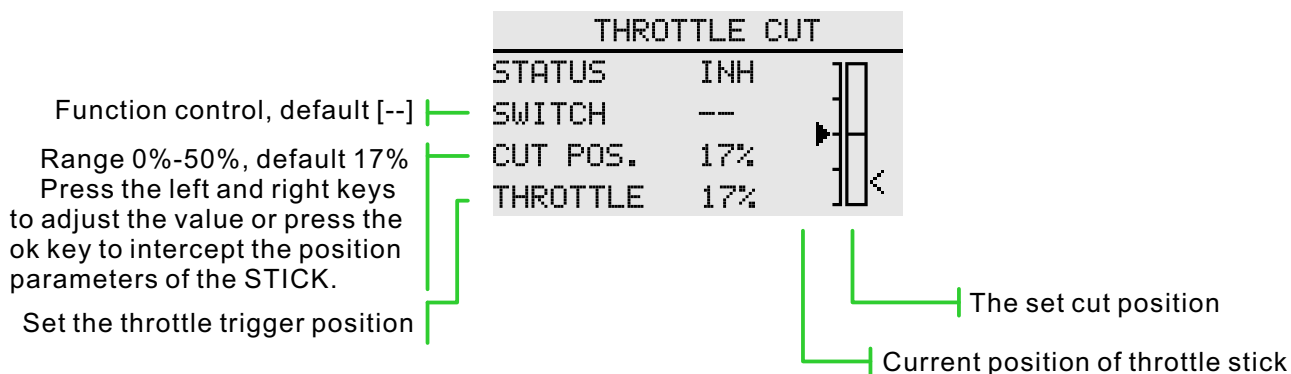

### Cut position setting

- 1 Status is switched to "ACT"
- 2 Click the "Switch" button to pop up the "Switch Assignment" interface and select the control switch.
- 3 Turn on the selected "cut control switch", the engine stick is in the idle down state, adjust the rate until the engine (motor) stops completely.  
Please pay attention to the throttle connection here, do not let the servo exceed the travel.

\* Fly Mode: set "Fly Mode" control switch in "Model Menu" → "Fly Condition". Switch through the switch, respectively for function setting.

**DANGER** The "cut position" must not be set higher than the lowest speed of throttle position. It is dangerous if the engine runs at high speed.



## STICK ALARM

Interface path: WFLY→[MODEL MENU]→[STICK ALARM]

This function is used to make a sound prompt every time the remote control throttle stick passes the set position when the model is operated. It is convenient for the operator to confirm the throttle position.

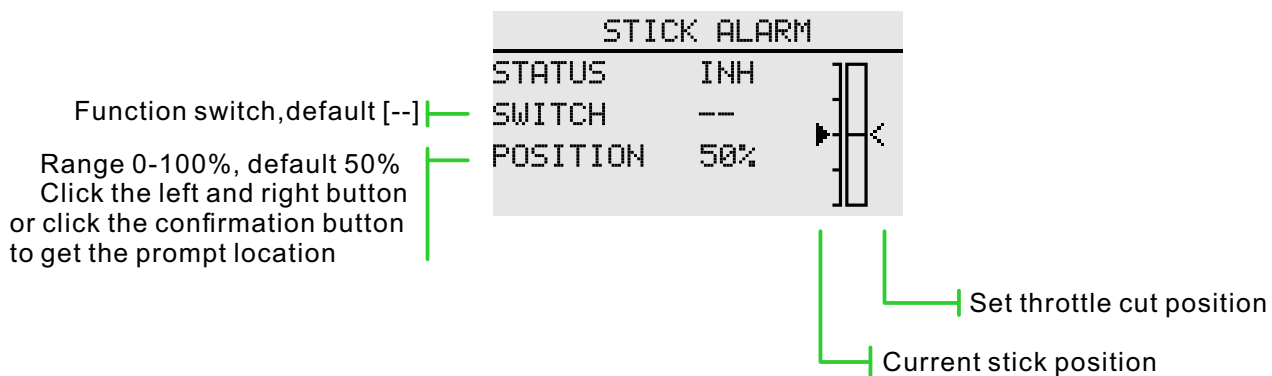

## GYRO

Interface path: HOME/MON. → [MODEL MENU] → [GYRO]

This function is used to adjust the gyroscope sensitivity. Set the sensitivity and mode of operation (normal/AVCS) for each flight condition or switch.

Condition mode	
MODE	CONDITION
POSITION	NORMAL
STATUS	ON
TYPE	AVCS

The control gyro sensitivity can be activated by "Fly Condition" or by assigning switches, knobs, and so on.

3 modes can set the sensitivity separately

Switch mode	
MODE	SWITCH
POSITION	1
SWITCH	--
STATUS	ON

Each control switch may be provided gyro respectively, three kinds of sensitivity can be provided.

A switch, knob, etc. can be set to activate the sensitivity value of the specified position of the switch.

Disable and enable the current Gyro configuration group.

2/2	
TYPE	AVCS
RATE	AVCS100%
TUNING	--
	0% [0%]

Normal mode, (AVCS) locktail mode.

Gyro operation mode. Normal, AVCS100%

Set the associated tuning control switch, knob, etc. for sensitivity adjustment

Control switch current real-time position

Can set the trim range value  $\pm 20\%$

### Function setting

1 When using the function, first assign the function channel on the [Function] interface, and set the "Switch" and "Trim" to [--] in [Function].

2 Mode selecting. Optional "switch" or "Fly condition".

3 Position selecting. In each mode, there are 3 groups of positions to choose from, and the corresponding sensitivity can be set separately. In the "switch" mode, you need to select the position switch, the default is [--].

4 Status selecting. Select whether the "Position" configuration above is enabled or not.

5 Type selecting. Select the sensitivity type of the corresponding work for the current "position".

6 Ratio adjustment. The options vary depending on the type option ("Normal" type, "Rate" range 0%-100%; under "AVCS" type, "Rate" range is Normal[0~100%], AVCS[0~100%]).

7 Trim the switch selection and trim the ratio setting. Sensitivity tuning switch, the default is [--]; the rate value can be set to  $\pm 20\%$ . Used for trimming the sensitivity.

The sensitivity required for different flight modes is different, so switch the conditions (Position) separately for sensitivity adjustment.



A series of horizontal dashed lines spanning the width of the page, providing a template for writing.

# ET08

**Shenzhen WFLY Technology Development Co., Ltd.**

Address: 4th Floor, Building C2, Xiangli Industrial Park, Heping Yiye Road, Fuyong Street, Baoan District, Shenzhen  
Zip code: 518055  
Website: [www.wflysz.com](http://www.wflysz.com)  
Overseas after-sales mailbox: [service@wflysz.com](mailto:service@wflysz.com)  
Fax: 26585126

